

# Acoustic Test Facilities

A complete solution to all types of acoustic test facilities







**Page**

**4** Overview

**26** Automotive Facilities

**72** Industrial and OEM Facilities

**94** High Performance Acoustic Test Facilities

# IAC Making the world a Quieter Place

# Acoustics

Founded on an unrivalled history of engineering with some of the most pioneering discoveries in the industry, the IAC Acoustics brand is synonymous with technological innovation.

From controlling noise at a power station to tuning the sound in a TV or radio studio, IAC Acoustics has had a positive impact on society and helped to shape what can be achieved to make speech more intelligible, music more enjoyable, reduce the impact of industrial noise and protect people's sense of hearing.

The continual success of our products and services over the decades has brought the brand a reputation for quality and reliability among customers, whether they are multinational corporations or independent family businesses. This is supported by the expertise and passion of our workforce, the people behind the products, including designers, engineers and industry specialists.

To face the ever increasing noise reduction demands of the future, we will strive to further enhance our ability to reduce excessive noise. We aim to focus on developing tomorrow's solution today, innovating faster and delivering solutions that meet the requirements of the next generation. In doing so, we will stay true to our key values and founding philosophy to make the world a quieter place.

making the world a quieter place





Turnkey complete acoustic test facility for Cummins Power Generation in Fridley, Minnesota

### Leading Supplier of Acoustic Test Chambers

IAC is one of the largest suppliers of acoustic test chambers and facilities in the world, with hundreds of installations worldwide. As the world's largest manufacturer of noise control products, IAC is able to utilise its expertise and bring together many different products for use in an acoustic test facility. Being able to supply a complete package reduces overall project spend and minimises the number of required suppliers. All IAC products have an individual acoustic rating and when accompanied by a laboratory certificate, give peace of mind about the overall performance of a completed facility. With such a detailed knowledge of acoustics, IAC is capable of tailoring solutions to meet the exact requirements of the client without compromising performance.

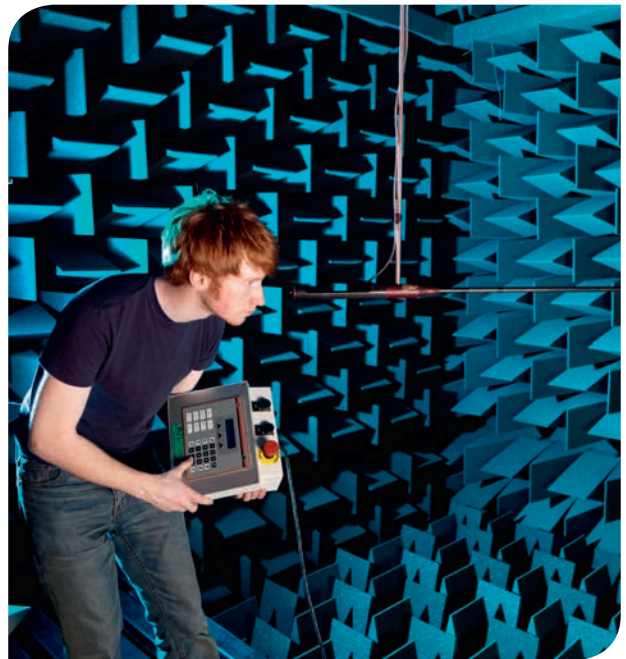

Fully anechoic chamber at the National Physical Laboratory (NPL) in London, UK  
*Image Courtesy of NPL*





## Acoustic Test Facilities for Manufacturers of:

- Motor cars
- Motorcycles
- Industrial engines
- Diesel generators
- Mechanical plant equipment
- Home appliances
- Office machines
- Electronic components
- Computers
- Mobile phones
- Hi-fi equipment

IAC has also supplied facilities to academic research organisations, government agencies and independent test houses.

## Turnkey Suppliers

IAC has successfully carried out a number of turnkey acoustic test facility projects around the world. As a turnkey supplier, everything from the initial concept design through to the final commissioning is carried out by IAC. As part of the turnkey process, IAC will also be involved in:

- Planning applications with local authorities
- Noise surveys and acoustic mapping
- Architectural design of buildings
- Mechanical and electrical installation design
- Appointing reputable sub-contractors

By opting for a turnkey solution, costs can be consolidated via one single supplier, reducing overall spend and minimising administrative input. This is particularly effective if many different acoustic facilities are being installed at one location or if a complete building is required.



Hemi-anechoic chamber for Dana Trucks, USA

## IAC's Capabilities

Since 1949, IAC has designed and constructed thousands of acoustic test facilities including several hundred small anechoic and reverberation chambers.

These controlled environments encompass a wide range of performance specifications – from simple quality control requirements to elaborate high precision acoustic measurements.

IAC's design engineers and research physicists bring a wealth of experience to provide data for an informed discussion on how to select free-field anechoic chambers and diffuse-field reverberation rooms.



## What is an Anechoic Chamber?

An anechoic chamber can be considered similar to a precision acoustical measurement instrument, providing a free-field environment without noise interference or sound reflection.

In an ideal free-field environment, the inverse square law would function perfectly. This means that the sound level from a spherically radiating sound source decreases by 6dB for each doubling of distance from the source.

For a free field to exist with perfect inverse square law characteristics, room boundaries must have a sound absorption coefficient of unity at all angles of incidence. In practice this is usually not quite perfect and deviations from the inverse square law are to be expected.

Table 1 highlights the maximum allowable deviations from the inverse square law as set out by ISO 3745 which states that “an anechoic room provides the preferred environment for measurements with the smallest uncertainty.”

Type of Room	1/3 Octave Band Centre Frequency, Hz	Allowable Difference, dB
Fully Anechoic (Free-Field)	←630	± 1.5
	800 to 5,000	± 1.0
	→6300	± 1.5
Hemi-Anechoic (Simulated Free-Field)	←630	± 2.5
	800 to 5,000	± 2.0
	→6300	± 3.0

**Table 1** – Maximum allowable difference between the measured and theoretical levels

## Construction of Anechoic Rooms

For anechoic rooms to function well, a number of acoustic, mechanical, electrical and aerodynamic considerations apply. These will include some, or all, of the following:

- Anechoic treatment selection
- Cut-off frequency
- Internal acoustic ambient noise level
- Noise reduction
- Vibration isolation
- Silenced ventilation systems
- Acoustic doors – operation and sizing
- Interior floors – cables and / or gratings
- Lighting and electrical systems
- Overall structural design considerations
- RF shielding requirements





## Noise & Vibration Isolation Characteristics

A well constructed room must provide good sound isolation against external noise so that resulting internal noise will not invalidate acoustic measurements. This may require the use of single or double-wall construction with appropriately designed vibration isolation to

adequately reduce air – and / or structure-borne noise transmission.

For best results, anechoic facilities should be individual structures, separate from any host building walls.



## Anechoic Wedges

One practical well proven method to achieve a free-field is to shape sound absorbing material into wedge configurations for mounting on to the interior surfaces.

The wedge shaped geometry ensures a gradual change in the acoustic impedance of the transmission media, ensuring that sound waves are absorbed by the material, rather than reflected at an interface.

The effectiveness of the absorption depends on the geometry and materials used.

The lowest frequency at which the absorption is effective (cut-off frequency) is inversely proportional to the depth of the wedge.

IAC's own impedance tube is used for critical adjustment of wedge dimensions before finalising each design.

Due to variations in material characteristics, statistical quality control measures are employed during wedge production to ensure specified acoustic performance.





## IAC Metadyne® Wedges

Metadyne® anechoic and hemi-anechoic test rooms have been chosen by the world's leading companies for the many unique advantages they have over rooms built using other materials, such as glass fibre or foam.

Metadyne® wedges were developed by IAC as a solution to some of the problems associated with using 100% foam or glass fibre. IAC was the first manufacturer to provide acoustic performance of the highest standard with a range of wedges which are entirely encased in perforated metallic casings.

Metadyne® wedges are ideal for large facilities which require low frequencies to be absorbed for testing products such as cars or engines. The rugged wedge construction and their long life span offer advantages to laboratories working with heavy equipment and / or flammable materials.

All Metadyne® wedges are manufactured in IAC factories across the globe to set standards and tolerances. This means a consistent finish can be achieved on large global projects and also ensures the acoustic performance of each wedge.

### Metadyne® metal-faced anechoic wedges offer:

- Guaranteed acoustic performance, with very low cut-off frequencies
- Compliance with international test standards, including ISO 3745, ISO 3744, ISO 26101
- Superior fire and impact resistance
- Greater durability and a longer lifespan than any other wedge type
- Ease of cleaning to ensure an "as new" appearance throughout their working life
- A bright, healthy and safe working environment for test personnel
- Bespoke paint options available to match corporate colours

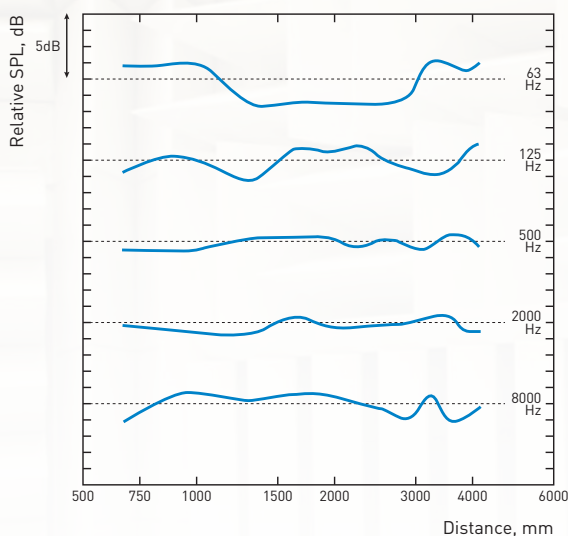

Inverse square law curves for a hemi-anechoic room with Metadyne® wedges fall well within acceptable ISO tolerance standards. Inside clear dimensions: 6426 x 9500 x 3607mm cut off frequency 60Hz



# 50Hz Metadyne® LF Wedge

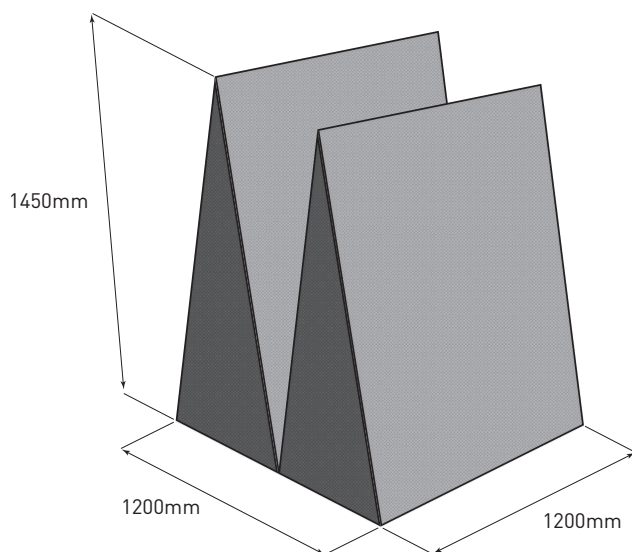

## IAC 50Hz Metadyne® LF Wedge Test Report

Test Report Number: 04036-119

Module Size: 1200mm x 1200mm x 1450mm

Tested in accordance with ISO 10534-1:1996 Acoustics — Determination of sound absorption coefficient and impedance in impedance tubes — Part 1: Method using standing wave ratio.

Cut off frequency to ISO 10534 : 50Hz

Frequency, Hz	Sound Absorption Coefficient
40	0.903
50	1.000
60	0.995
70	0.995
80	0.993
90	0.999
100	0.997
120	0.997
140	0.997
160	0.997
180	0.998
200	0.999

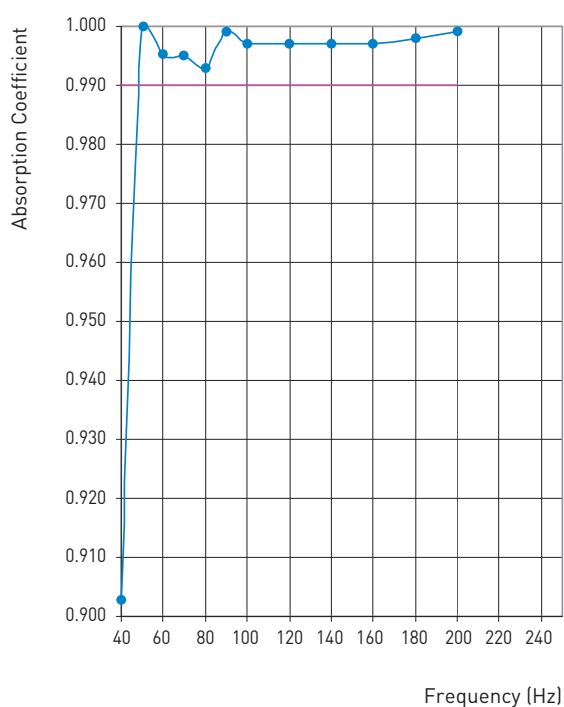

# 63Hz Metadyne® LF Wedge

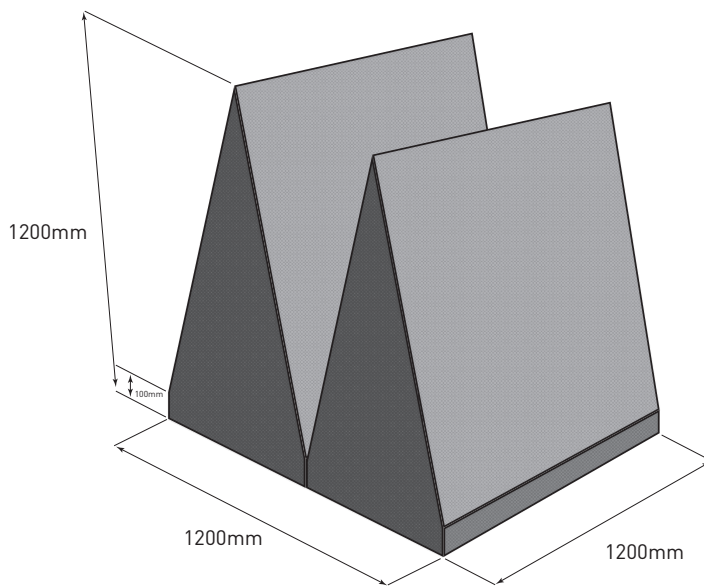

## IAC 63Hz Metadyne® LF Wedge Test Report

Test Report Number: 020508-3

Module Size: 1200mm x 1200mm x 1200mm

Tested in accordance with ISO 10534-1:1996 Acoustics — Determination of sound absorption coefficient and impedance in impedance tubes — Part 1: Method using standing wave ratio.

Cut off frequency to ISO 10534 : 63Hz

Frequency, Hz	Sound Absorption Coefficient
40	0.726
50	0.903
63	0.993
80	0.994
100	0.998
125	0.997
160	0.994
200	0.998
250	0.998

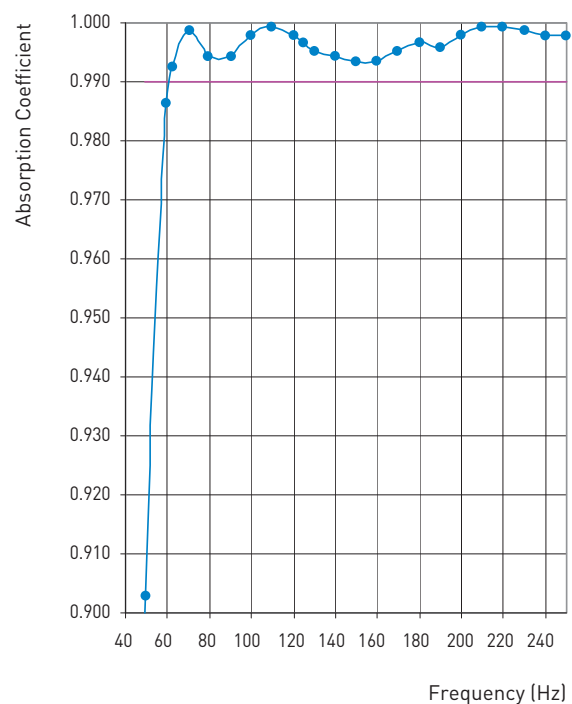



# 70Hz Metadyne® LF Wedge

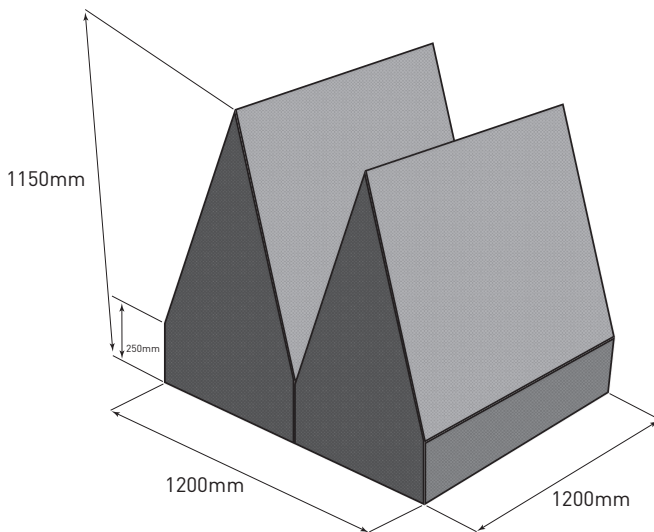

## IAC 70Hz Metadyne® LF Wedge Test Report

Test Report Number: 160408-1

Module Size: 1200mm x 1200mm x 1150mm

Tested in accordance with ISO 10534-1:1996 Acoustics — Determination of sound absorption coefficient and impedance in impedance tubes — Part 1: Method using standing wave ratio.

Cut off frequency to ISO 10534 : 70Hz

Frequency, Hz	Sound Absorption Coefficient
40	0.721
50	0.838
63	0.969
80	0.999
100	0.999
125	0.999
160	0.997
200	0.995
250	0.998

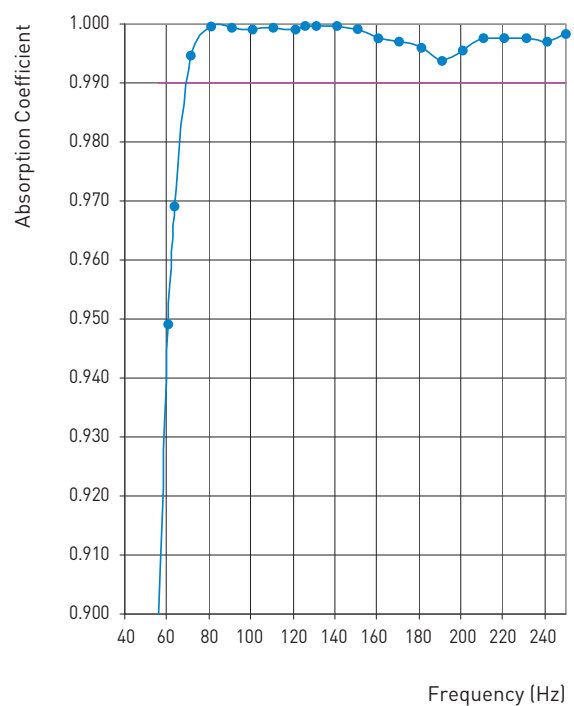

# 100Hz Metadyne® LF Wedge

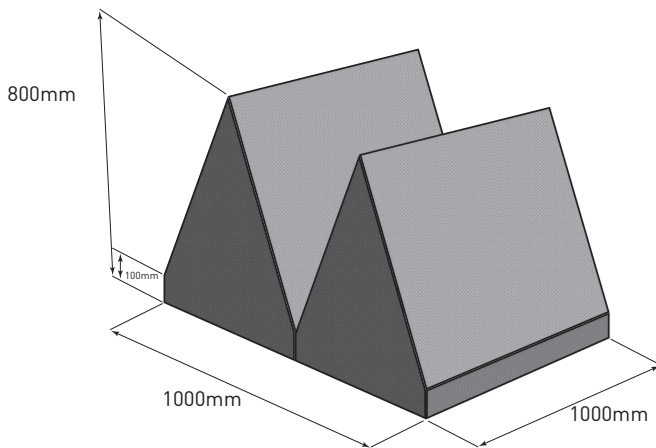

## IAC 100Hz Metadyne® LF Wedge Test Report

**Test Report Number: 290808**

**Module Size: 1000mm x 1000mm x 800mm**

Tested in accordance with ISO 10534-1:1996 Acoustics — Determination of sound absorption coefficient and impedance in impedance tubes — Part 1: Method using standing wave ratio.

Cut off frequency to ISO 10534 : 100Hz

Frequency, Hz	Sound Absorption Coefficient
80	0.958
100	0.992
125	0.994
160	0.995
200	0.993

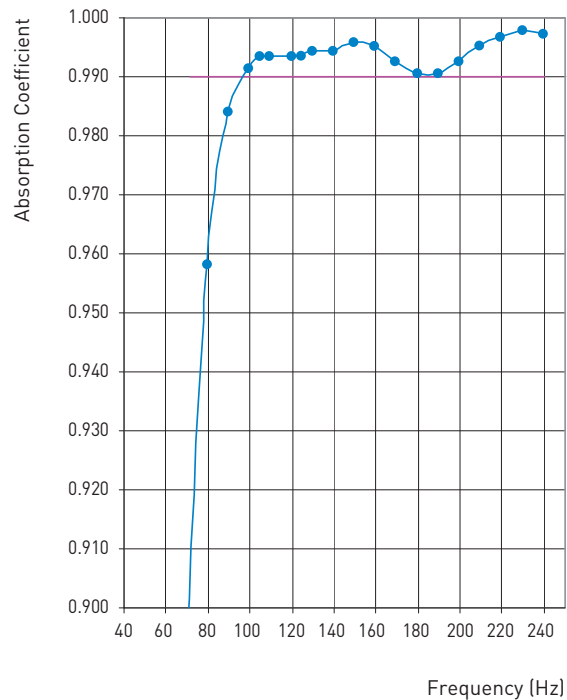

# 125Hz Metadyne® LF Wedge

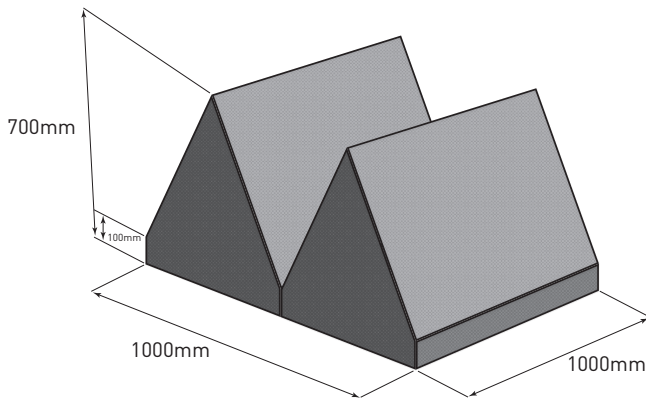

## IAC 125Hz Metadyne® LF Wedge Test Report

Test Report Number: 160408-1

Module Size: 1000mm x 1000mm x 700mm

Tested in accordance with ISO 10534-1:1996 Acoustics — Determination of sound absorption coefficient and impedance in impedance tubes — Part 1: Method using standing wave ratio.

Cut off frequency to ISO 10534 : 125Hz

Frequency, Hz	Sound Absorption Coefficient
80	0.893
100	0.981
125	0.998
160	0.994
200	0.995
250	0.997

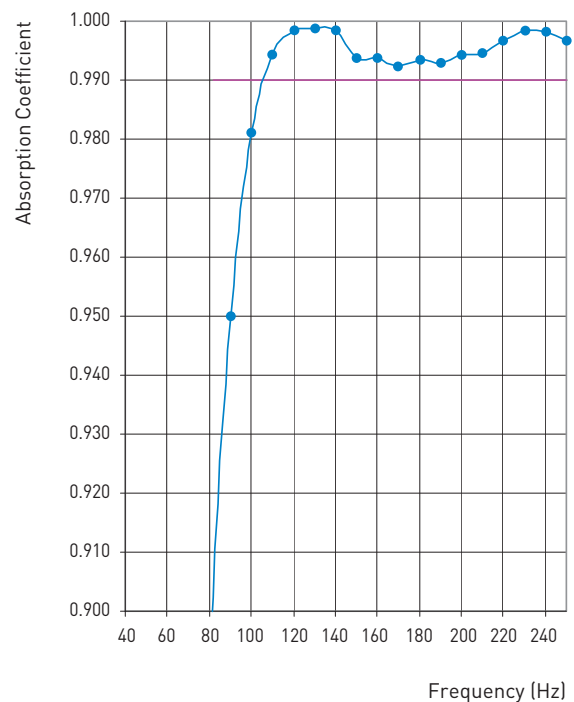



## Wedge Testing – The Impedance Tube Method

If an anechoic chamber is to meet the free-field criteria of ISO 3745, the wall lining is required to have a normal incidence absorption coefficient  $\alpha$  of no less than 0.99 when tested in an impedance tube (plane wave absorption). The cut-off frequency of the wedge is the lowest frequency at which this criterion is met. IAC has a strict testing regime ensuring that all anechoic wedges are designed and verified at full scale within our impedance tube.

### Impedance Tube Features

- The impedance tube is designed using the guidance set out in ISO 10534-1 'Acoustics – Determination of sound absorption coefficient and impedance in impedance tubes – Part 1 Method using standing wave ratio', and ASTM C 384-98
- Walls constructed from 20mm plate with 140mm thick concrete and a 100mm air gap to ensure minimal losses and increase the accuracy of measurements
- The tube length limits the lowest measurement frequency (40Hz), and its cross-sectional dimensions limit the upper frequency limit (264Hz)
- The tube cross-section is big enough to test full size wedges

### Background Theory

The equipment is very straightforward, the only required measurements are the sound pressure levels at multiple positions along the tube. For each frequency of interest, a speaker outputs a pure tone which creates a standing wave within the tube and a trolley mounted microphone automatically traverses this sound field and measures the sound pressure level at each point, recording the maximum and minimum values.

The absorption coefficient is determined from the ratio of the maximum to the minimum sound pressure level in the tube.

### Wedge Testing in Reverberation Chamber

In addition to the impedance tube method, IAC anechoic wedges are also tested in independent laboratories to ISO 354, "Measurement of sound absorption in a reverberation room." By carrying out these additional tests, IAC ensures that each wedge design exhibits excellent absorption characteristics at frequencies above the upper limit of the impedance tube.

Proving the adequacy of the room absorption prior to installation is the best method for ensuring a guaranteed chamber performance.

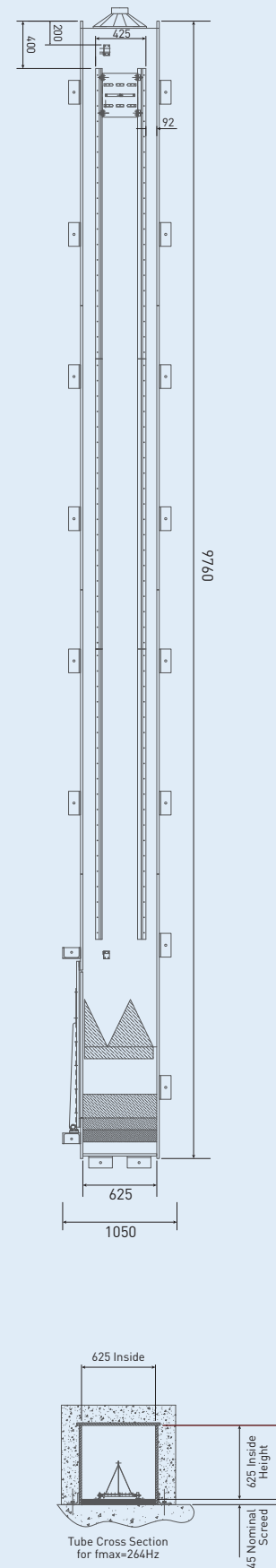

## Data Acquisition

IAC's own system captures all of the data and manages all subsequent data reductions, providing repeatable results on a straightforward and user friendly sheet. To capture the amount of data manually would not be time

effective, in fact, a single wedge test takes less than 30 minutes to complete. This fast testing method allows IAC to make changes to the profile of anechoic wedges and optimise the material configuration.



Typical view of IAC's data acquisition system for impedance tube testing

## Wedge Test Results

A wedge will be considered suitable if the results show a normal incidence sound absorption coefficient greater than 0.99 at and above the required cut-off frequency.

The results opposite are those for a wedge with a cut-off frequency of 70Hz.

The software allows any individual frequency to be tested within the limits of the tube.

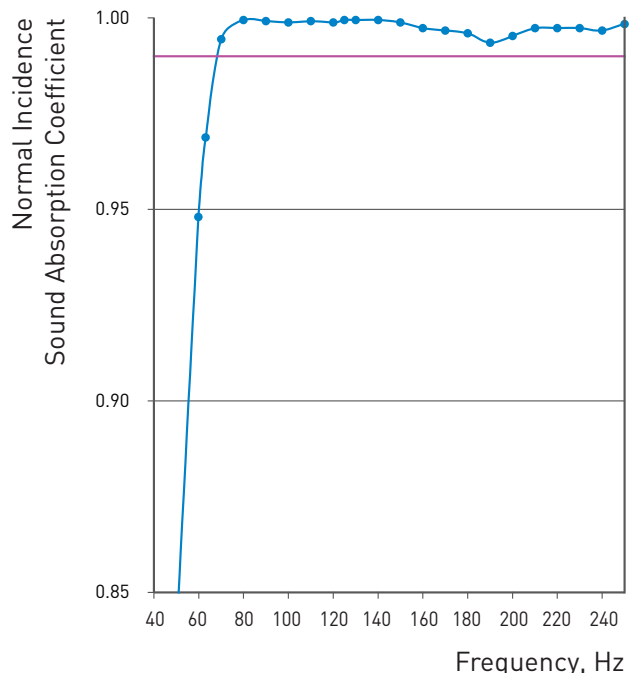

## Wedge vs. Flat Anechoic Linings

Flat acoustic absorber panels can be used in a chamber to create a lower grade free-field, anechoic space. These panels are typically used if space is limited as they take up less room than a chamber lined with wedges. IAC's flat anechoic absorption range, Planarchoic™ can be tuned to deal with certain frequencies in the same way as our range of Metadyne® wedges.

Although Planarchoic™ lined chambers have the benefit of increasing the available floor space for testing, the free-field area is reduced (as seen in the diagram below).

Planarchoic™ free field rooms are always hemi-anechoic, usually large in size and can be placed on a hard floor in the absence of structurally transmitted vibration and noise. Planarchoic™ rooms are suitable for sound measurements of cars, lorries, fork-lifts, transformers and other industrial equipment.

Special care must be taken in the relationship of Planarchoic™ room volume to test object dimensions to assure a free-field environment, due to the reduced area for taking viable measurements.

Due to flat surfaces creating even a small amount of sound wave reflection, despite being acoustically treated, their performance is typically not as great as anechoic wedges.

Better acoustical measurements can be taken and relied upon using a chamber lined with wedges. All IAC chambers with wedge linings are certified to ISO 3745 for the determination of precision acoustic power levels (Grade 1). Chambers with flat absorbers applied to surfaces typically only qualify for ISO 3744 which is for non-precision acoustic power level measurements (Grade 2).

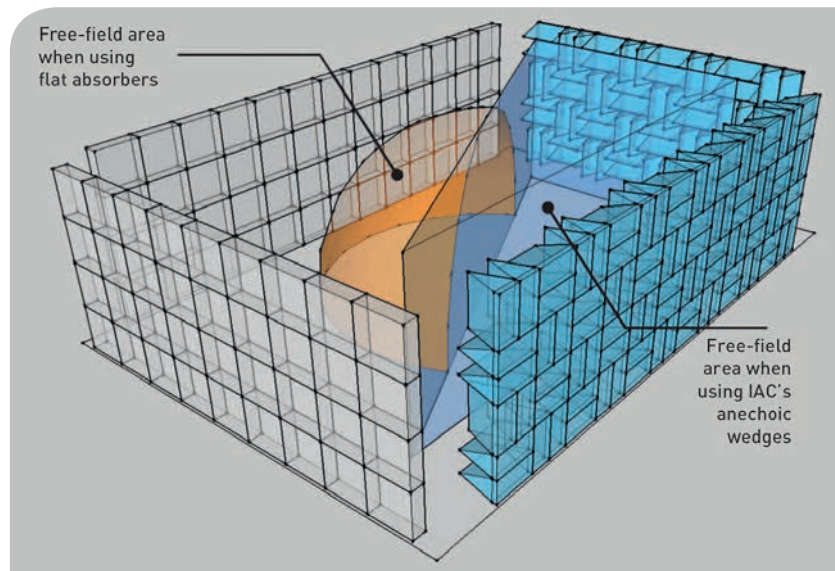

Free-field area inside a hemi-anechoic chamber comparison between surfaces lined with flat absorbers and wedges



Hemi-anechoic room showing flat absorbers on the walls with wedges in the roof to increase the amount of absorption



## IAC Noise-lock® High Performance Acoustic Doors

IAC is a leading supplier of high performance acoustic doors with over fifty years experience in door design and manufacture. IAC offers a wide range of standard models, or can design and make doors to suit specific applications.

Over 1,000,000 IAC acoustic doorsets have been installed in industrial and commercial buildings throughout the world. They have been used in many applications in addition to acoustic test facilities and offer a high performance solution to situations where sound must be contained within or excluded from a room or building.

All IAC Noise-lock® doors and frames are designed to be acoustically compatible with rooms in terms of sound transmission loss. Hinges can either be cam-lift or level swing, depending on the requirements and double magnetic seals assure acoustic performance. Threshold compression seals can be provided with or without a sill.

## IAC Noise-lock® Acoustic Doors for Anechoic Facilities

Specialist doors are required for anechoic facilities in order to maintain the same level of absorption as other walls and surfaces.

Anechoic wedges can either be attached directly to the inner face of Noise-lock® acoustic doors, or a separate 'basket' style arrangement can be used.

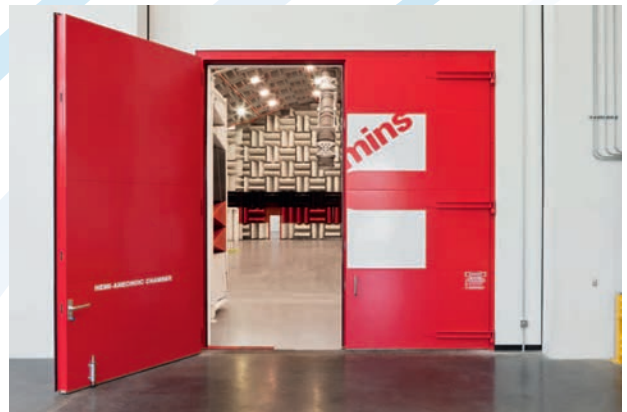
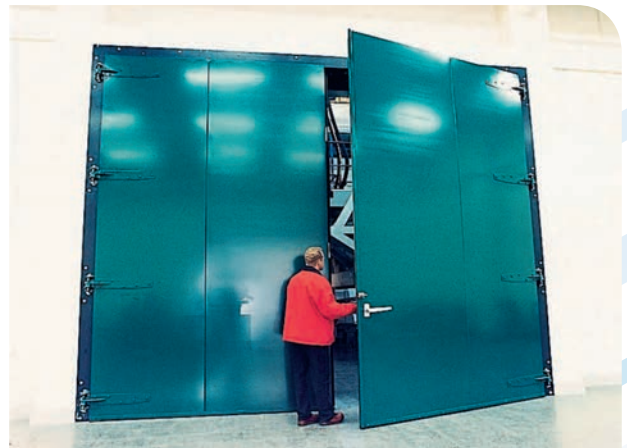

## IAC Wedge Basket Doors

To maintain an absorbent wedge finish on all walls, entrances to an anechoic facility can solely utilise basket doors, or be used in conjunction with IAC's Noise-lock® range of high performance acoustic doors.

Depending on the available space and the type of wedge used, IAC can offer a cost effective solution to accommodate basket doors for any situation.





## Reverberation Rooms

### What is a reverberation room?

A reverberation room can be considered the opposite of an anechoic chamber because its boundaries reflect, rather than absorb sound energy. Reverberation rooms are designed for the determination of sound power output of noise sources, transmission loss of partitions, insertion loss of silencers, response characteristics of microphones and random incidence absorption coefficients of materials. They are also used for high-intensity noise-level fatigue testing of aircraft, space vehicles and other equipment.

The purpose of a reverberation room is to create a highly diffused acoustic measurement environment, defined as a sound field in which acoustic energy flows equally in all directions.

A reverberation room must provide sound isolation against extraneous noises and an environment which can be temperature, pressure and humidity controlled.



IAC has installed many field-proven reverberation rooms in different configurations. With more than 60 years experience, IAC is the pioneer and leading company in the design, construction and commissioning of modular reverberation chambers.

### Construction of Reverberation Rooms

For a reverberation room to perform correctly, careful consideration must be given to a number of factors which include:

- Test standard or method
- Interior volume
- Room dimensions in relation to test object size
- Interior working space
- Lowest frequency band of interest
- Internal acoustic ambient noise level
- Noise reduction
- Vibration isolation
- Silenced ventilation systems
- Doors and access
- Lighting and electrical systems
- Overall structural requirements

### Standard Features

IAC reverberation rooms come fully equipped with the following features:

- IAC Hardliner™ panel construction
- Double / single wall and ceiling construction
- IAC ventilation system coupled to building supply
- Interior lighting and power
- A standard size IAC Noise-lock® acoustic door
- Complete certification and commissioning tests

### Options

- Self-contained air handling/ventilation system
- Additional/larger door
- Access panels for equipment and test openings
- Air mounts, or other types of vibration isolation
- RF shielding
- Turning vanes and/or diffusers



## IAC Ventilation Systems

A ventilation system must provide adequate air circulation at sound pressure levels below design criterion. IAC Quiet-vent® silencing systems are designed to provide approximately 15 air changes per hour in a typical anechoic facility. If specialist heating/cooling needs are required, then IAC can custom-design a system to meet your needs.

IAC is an industry leader in the design and construction of silencing devices for air/gas flow systems. These range from minimal air changes to large elaborate intake and exhaust silencing systems to accommodate engine research within an acoustic test facility.

IAC has designed and manufactured hundreds of thousands of silencers for soundproof rooms, HVAC systems, industrial machinery, power plants, engine test cells and gas turbines.



## Climatic Chambers

IAC can enhance ventilation systems to cover a wider range of temperatures within the chamber. IAC Metadyne® wedges are able to withstand high and low extremes without degradation, provided that the temperature cycling is controlled for condensation.

Areas of potential complication are frequent room calibration for differing temperatures, structural design for very low temperature, personnel safety, test equipment durability and operation.

Should extreme temperature testing be required including fluctuations in humidity, IAC can work with clients to achieve the best possible results.

making the world a quieter place

## Isolation

With regard to chamber isolation, at design budget stage, there is usually insufficient information to confirm whether structural isolation of the floor slab is or is not required. IAC would review proposed site layouts, Geotech reports and space planning to analyse what may affect the chamber performance based on

surrounding facilities. IAC has found through experience, that other than in extreme cases, with good isolation of the dynamometer and plant room equipment, an expansion joint 'break' in the floor slab would be enough to eliminate most problems for general NVH.

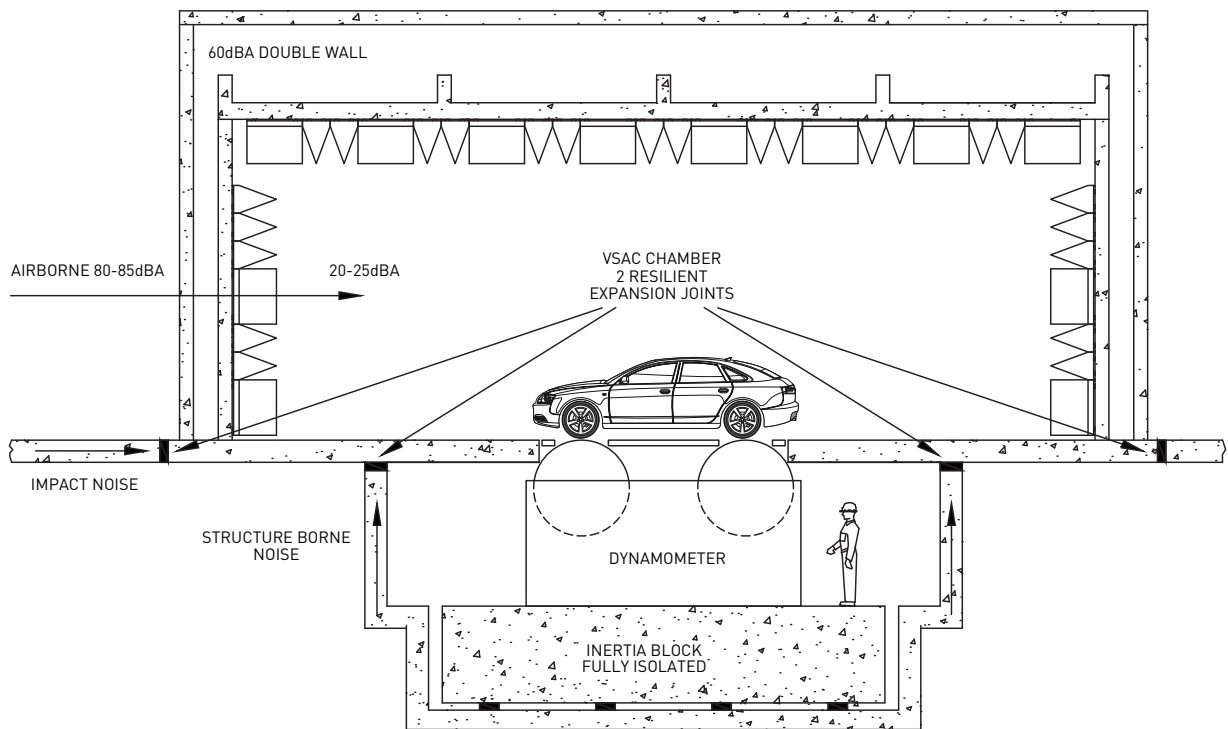

Spring mounts being installed for floating floor system



## Ancillary Equipment

In addition to core acoustic products, IAC is also able to offer full integration of other ancillary equipment within facilities, including electrical items (lighting, alarms, sensors, CCTV etc) and mechanical plant and equipment (chassis dynamometer, instrumentation, chillers etc).

### Cranes, Hoists & Vehicle lifts

IAC has supplied many different types of systems ranging between 2 post lifts, 4 post lifts, recessed floor systems, overhead cranes and runway beam cranes.

### Lighting

IAC supplies the latest LED-based lighting system that is designed to provide a diffused light field. IAC also include emergency lighting as necessary. The lighting provided ensures that horizontal luminance in the working area at 1m above the floor is no less than 600lux and their lifespan rated at no less than 75,000 hours. The lights are selected to achieve the lowest possible background noise levels and ambient temperatures.

### Plant & Test Equipment

Air cooled external chillers with buffer vessels and pump systems for chilled water cooling, chassis and engine dynamometers.

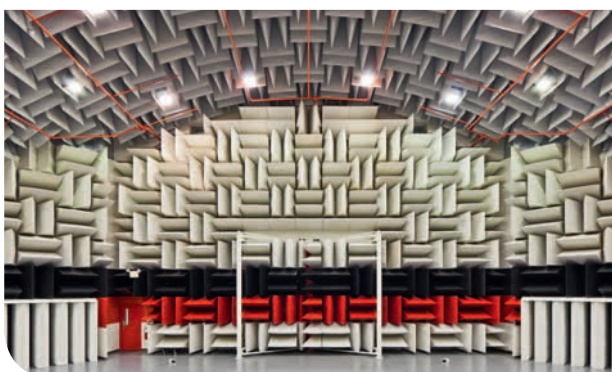

Hemi-anechoic room highlighting IAC's chosen lighting system alongside the client's preferred fire suppression system



Plant room for turnkey acoustic testing facility



Below is an example of a project for Volvo Cars where the facility was completely overhauled by IAC to include new wall linings, acoustic doors and a silent ventilation system.

**Before**

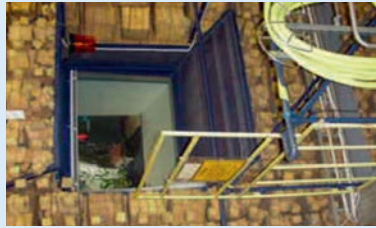

**After**



Refurbished anechoic pass-by chamber facility with foam and IAC Metadyne® wedges

## Refurbishment

The last two decades have seen an explosion in acoustic testing by automotive manufacturers, component suppliers, engineering institutions and educational organisations together with a rapid growth in the construction of new acoustic test facilities.

Many older facilities have become tired and may contain materials that are now considered unsuitable and hazardous. IAC can provide your facility with a much needed upgrade complying with current day standards and utilising state of the art robust materials and technology. All IAC products are rigorously tested and the new materials permit “corporate styling” and high aesthetics to suit each customers’ individual requirements.

**Upgrade products include:**

- Survey and design
- Existing chamber strip-out
- Replacement wedges
- Replacement doors
- Replacement ventilation
- Replacement lighting and electrics



## IAC Curved Roof for Turnkey Hemi-Anechoic Chambers

Main contractors sometimes struggle to provide a smooth, flat and level surface to the underside of concrete roofs or walls, to allow the installation of IAC's wedge support structure. Because of the spans, the concrete thickness tends to escalate where the roof load can easily exceed 500 tonnes (all of which needs supporting). A builder's solution, normally, is to install deeper steel beams and hollow-pot type ceiling, however, this is not acceptable physically or acoustically for the wedge system.

This heavy design also increases the steel tonnage, foundations, costs and at the end there may be no acoustic guarantees from the builder. For the same size, with a guarantee, IAC can supply a flat or curved roof system that will only weigh a fraction of an equivalent concrete solution at 30 tonnes.

Please refer to the adjacent photos of IAC's solution of level or 'curved' panel ceilings. The curve also has the added benefit of improving the anechoic performance inside the chamber and the reduced wall height reduces cost and allows space for return air ductwork above the rooms.



Hemi-anechoic chamber with a curved roof during construction phase



The same site, once the chamber was completed and the wedges installed



Typical building shape from outside a turnkey facility with a curved roof



## Facility Testing and Final Commissioning

IAC offer a comprehensive commissioning service for all acoustic test facilities to ensure the performance criteria is met and an exact frequency cut-off determined.

IAC has been represented on the International Standards Organisation working group to develop a standardised test method for anechoic and hemi-anechoic chambers. The new standard (ISO 26101 – Acoustics — Test methods for the qualification of free-field environments) provides a test method applicable to all free-field environments, as an alternative to the method given in the Annex of ISO 3745 which is primarily for anechoic rooms designed for sound power measurement.

When commissioning a facility, IAC will determine the effectiveness of the chamber by making sound pressure level measurements as a function of distance from a sound source situated in the centre of the chamber, and comparing these with the corresponding values predicted by the inverse square law.

In addition to commissioning the test cell, IAC also carries out ambient noise levels (including the ventilation system) and transmission loss, reverberation time and dynamometer noise measurements. As part of the commissioning procedure, IAC also fully tests and commissions the ventilation system in the facility, including air flow balancing.



making the world a quieter place



# Automotive Test Facilities

- Hemi-anechoic Chambers
- VSAC
- Pass-by Chambers
- Powertrain NVH Test Laboratories
- Driveline Chambers
- Listening Rooms
- Modal Analysis Facilities
- Shake & Rattle Chambers
- Airbag Test Facilities
- Quiet Rooms







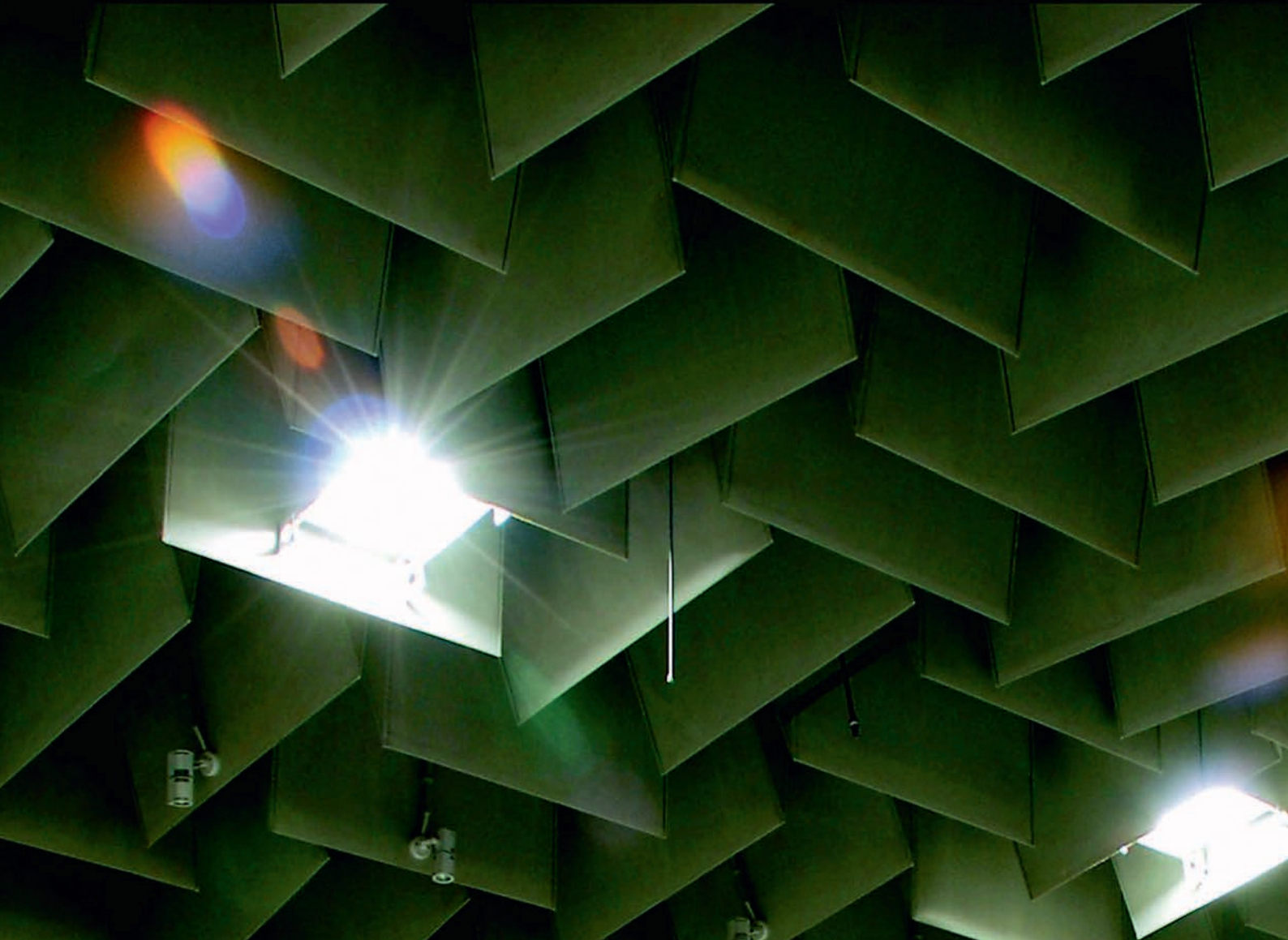

## A Complete Solution to Automotive Acoustic Testing

IAC can offer a complete turnkey service for the provision of automotive acoustic test facilities. With numerous projects around the world, each with very specific requirements, IAC can offer a central contact point for a new facility or overhaul and refurbishment of existing buildings.

The IAC turnkey service includes initial design concepts, all the way through to project management, testing and final commissioning of a facility.

By opting for a turnkey service, this enables IAC to focus on delivering the optimum acoustic facility by designing a building which is fit for purpose, utilises the available space effectively and performs to the specified criteria.

With over 60 years experience in providing acoustic test facilities, IAC has built up extensive relationships with international dynamometer companies to offer your preferred choice of supplier.

## Uses of Automotive Testing Chambers

Automotive anechoic and hemi-anechoic facilities are typically used for Noise Vibration and Harshness (NVH) and pass-by road simulation tests. Measurements are taken for cabin noise, engine compartments, intake and exhaust systems, vibration, powertrain mounting systems and tyre noise.

All IAC anechoic and hemi-anechoic chambers comply with ISO 3745 for standard sound power measurements.





“Over 40 years  
experience providing  
automotive acoustic  
test facilities.”

### Automotive Testing Chambers

There are many different types of acoustic testing chamber that apply to the automotive sector. IAC has supplied many of the following products and facilities across the world:

- Anechoic chambers
- Hemi-anechoic chambers
- Pass-by chambers
- Listening rooms
- Modal analysis rooms
- Psycho-acoustic laboratories
- Shake & rattle chambers
- Wind tunnels
- Anechoic wedges
- Flat anechoic panels
- Acoustic Air Handling Units (AHU's)
- Duct silencers
- Acoustic doors
- Silent intake and exhausts
- Wedge basket doors
- Modular acoustic buildings and enclosures
- Acoustic tuning panels
- Coupled rooms
- Transmission suites
- Jury evaluation rooms
- Air bag testing laboratories
- Engine test chambers
- Climatic chambers
- Refurbishments & overhauls
- Powertrain NVH laboratories



Fully anechoic chamber with 4x2 dynamometer for Porsche, Weissach, Germany

## Hemi-anechoic Automotive Pass-by Chambers

Road traffic noise is a main contributor to environmental noise, thus, it is intended to be reduced and limited by legislation in order to increase health and life quality. Vehicle pass-by noise tests are conducted according to the international standard ISO 362, which quantifies the noise emission of a vehicle in an urban traffic environment, by testing on an outdoor track.

Traditional field pass-by measurements are still the only way to certify a vehicle for exterior noise emissions during operation, but an indoor pass-by test provides an extremely powerful and repeatable method of troubleshooting exterior vehicle noise in the controlled environment of an anechoic chamber.

Instead of making the test vehicle pass two stationary microphones, indoor pass-by measurements place a row of microphones alongside the test vehicle whilst running on a chassis dynamometer and accelerated in the same way as it would be for a traditional pass-by measurement.

IAC has designed numerous hemi-anechoic pass-by chambers for automotive manufacturers across the world.



Hemi-anechoic pass-by chamber for Bajaj Motorcycles, India



## New ISO Standards

### ISO 362-3 Measurement of noise emitted by accelerating road vehicles

New developments to the ISO Standards are helping to ensure consistency across the latest vehicle tests.

Exterior noise measurement approval to the current ISO 362-1 standard must presently be carried out on certified outdoor test tracks.

Due to environmental influences, these traditional proving grounds do not give the consistency required by the increased demands of the motor industry.

Sound emitted from a vehicle should be tested under controlled conditions independent of weather and other environmental factors.





The forthcoming ISO 362-3 gives the specifications for test facilities to achieve a precision comparable to a certified type approval test track, thereby allowing indoor testing.

#### **ISO 16254 Measurement of minimum noise emitted by road vehicles**

With the advances in electromotive vehicles, the minimum sound level emitted is of concern for pedestrian safety.

ISO 16254 is in preparation by the relevant ISO committees to provide a method to measure the minimum noise emission of road vehicles, as well as to quantify the characteristics of any external sound-generation system installed for the purpose of conveying acoustic information about the approach, presence and/

or departure of the vehicle to nearby pedestrians. All IAC pass-by chambers conform to the current drafts of these standards and will allow measurement of noise emitted by an accelerating vehicle and the measurement of the minimum noise emissions.

**“All IAC pass-by chambers conform to the current drafts of these forthcoming new ISO standards.”**



## Vehicle Semi-Anechoic Chambers (VSAC)

VSAC chambers are typically used for the measurement of inner and outer noise & vibration of a car with 2WD or 4WD, typically during run-up and coast down and at constant speeds, including the measurement of intake and exhaust, engine compartment, steering wheel and seat rail vibrations.

VSAC chambers may also be used for carrying out measurements of powertrain mountings (engine vibration, and vibration transfer across mounts), noise source location (acoustic intensity), operational deflection shape identification, structure-borne transfer path analysis from powertrain mounts and other components and measurement of engine power characteristics.

## Powertrain NVH Chambers

Powertrain testing is typically carried out inside a hemi-anechoic chamber to ensure high acoustic absorbency. A typical layout for powertrain test cells is with 2 independent dynamometers sitting outside of the test chamber, leaving only the engine and gearbox inside the hemi-anechoic room. IAC powertrain chambers allow functional testing of various powertrain and transmission types in a virtual vehicle environment.

- Acoustic and vibration performance (acceleration, deceleration)
- Optimisation of the powertrain and driveline components (engine accessories, shafts, intake system)
- Base calibration of control units (ECU, TCU etc.) to improve the NVH performance

The flexible design of IAC powertrain test cells allow the installation of various transmission types:

- Manual transmission
- Automatic transmission
- CVT transmission
- Automated transmission
- Dual clutch transmission
- Hybrid transmission

The aim of this test rig is to perform tests on FWD and RWD Power Train systems for NVH R&D purposes.



Volvo VSAC showing exhaust and forced air cooling duct (FACD)

## Driveline Chambers

Driveline chambers are similar to powertrain test cells, except they have no acoustic treatment. Driveline chambers typically measure engine performance such as economy, timing, pressures and power. As no acoustic measurements are taken in this type of chamber, there is usually no need for acoustic linings to the inner walls. The exception to this may be if there are other acoustic-sensitive tests going on in adjacent rooms.

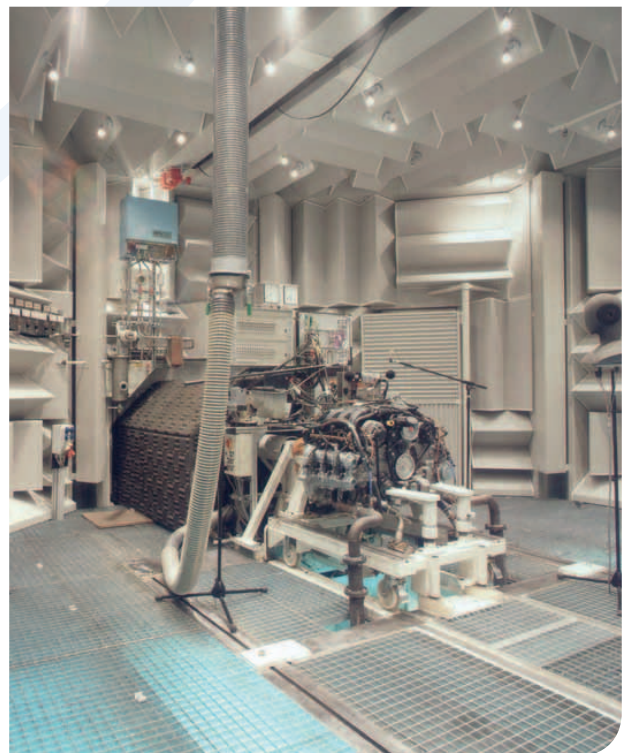

Typical IAC powertrain chamber

## Modal Analysis Rooms

Modal analysis facilities are used to measure the resonance and tone of bodywork panels on a vehicle.

Panels are struck with differing degrees of force and the resulting resonance measured. This type of testing is used to ensure panels do not excessively vibrate, causing unwanted noise. Panels which are found to have a high degree of resonance can be treated with additional supports and strengthening to overcome the problem.

Like listening rooms, IAC modal analysis laboratories are constructed from Moduline™ panels to isolate external noise from the facility. The room is then treated with IAC Varitone™ panels to tune the space for an optimum amount of absorption.

## Shake & Rattle Facilities

Shake and rattle facilities are typically used at the end of a production line before a vehicle leaves the factory. This is a final acoustic test to ensure there are no panels which squeak or rattle. Small, unwanted noises within a vehicle cabin are one of the main reasons for returns to dealerships, post purchase and this test helps to avoid dissatisfied customers.



Modal analysis facility at Skoda Cars, Czech Republic



Bespoke shake & rattle facility featuring IAC Metadyne® anechoic wedges at Rolls Royce, UK



A typical IAC listening room installation

IAC can provide a turnkey service for shake and rattle rooms providing the hydraulic 4-post test rig in addition to the acoustic treatments to the room to ensure no interfering sound transmission from other areas of the production facility.

## Listening Rooms

IAC has produced a number of listening rooms for testing the sound quality of various noises associated with a certain vehicle. These important facilities play a large part in the R&D process, utilising first hand market research data. The research data gathered, aids in 'tuning' a vehicle to sound a certain way and is typically very different across models.

Manufactured from IAC's Moduline™ panels, a modular acoustic construction panel system, the facilities have to be isolated from any other interfering noise to gain the best results. IAC Varitone™ or Accutone™ panels are then used inside the room to tune the absorption and hence reverberation times so that room reflections do not 'colour' the sound under assessment.

making the world a quieter place





Engine noise test cell, Porsche, Germany

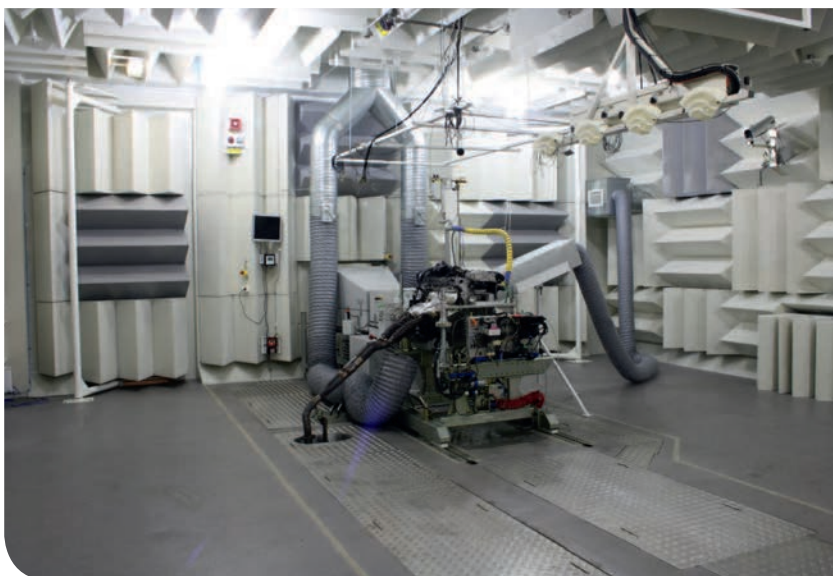

Engine test cell for Volvo

### Engine Noise Test Cell

Engine Noise Test Cells (ENTC's) are typically environments for testing a standalone engine. Usually hemi-anechoic in design, an ENTC shares many characteristics with IAC VSAC chambers, but without a chassis dynamometer. ENTC's typically have a cut-off frequency of 125Hz and feature a coupled exhaust extraction system, independent ventilation and cooling, a conditioned aspiration air intake set-up and the ability to accommodate either an AC or DC engine dynamometer.



## Airbag Acoustic Test Facilities

Testing airbags is a particularly noisy and dangerous procedure. Dealing with controlled explosions and instantaneous noise levels in excess of 140dB, airbag testing can have a detrimental effect on the health of staff working in the vicinity if it is not managed correctly.

IAC has experience in providing airbag testing chambers for both in-vehicle and off-vehicle testing.

Due to the levels of noise control required, airbag facilities are typically of a twin-wall Moduline™ construction with a large air gap between the two walls.

## Quiet Rooms

Quiet rooms are similar to VSAC's, except without a chassis dynamometer. Quiet rooms are typically facilities for taking acoustic measurements around a stationary or idling vehicle. Noise from components and tangible areas of a vehicle that a consumer will interact with such as handles, switches, door closures and windscreen wipers are measured in quiet rooms.

Due to the measurements being taken, quiet rooms need to be isolated from any other noise sources. Typically manufactured from acoustic walls and ceilings, the addition of anechoic wedges ensures minimal transmission of sound from other areas of the facility entering the test chamber.

Background noise typically  $\leq 20\text{dB(A)}$ .



Airbag in-vehicle testing chamber, Jaguar, UK



A typical IAC quiet room facility

## Ventilation Systems

In addition to the usual chamber acoustics, IAC normally designs and supplies the ventilation system so as to keep the full acoustic responsibility with one supplier.

IAC has an unrivalled wealth of experience in designing very quiet, large air movement systems.

The design of this type of system, within a limited space where control of noise, volume, temperature and pressure drop, is a very specialised skill. With turnkey expertise, IAC is able to co-ordinate this with the chassis dynamometer supplier and user.

Through extensive experience in working with acoustic silencers for air handling systems, IAC has the capability to design specialist ventilation packages tailored to the automotive testing industry.

Due to the nature of acoustic testing, the air which enters a test chamber needs to have controlled temperatures, velocities and levels of humidity. In addition to this, and more importantly, the air needs to be passed freely in to and out of the test area as quietly as possible.

This is to provide the required amount of heat removal during the test cycle.

IAC has designed a number of different intake and exhaust systems to cope with individual requirements. By using IAC's own products, which all have an individual acoustic rating, there is certainty of meeting even the most stringent of specifications.

IAC also manufactures a range of acoustic air handling units (AHUs) which are used in acoustic test facility projects to minimise the level of noise direct from the fan.

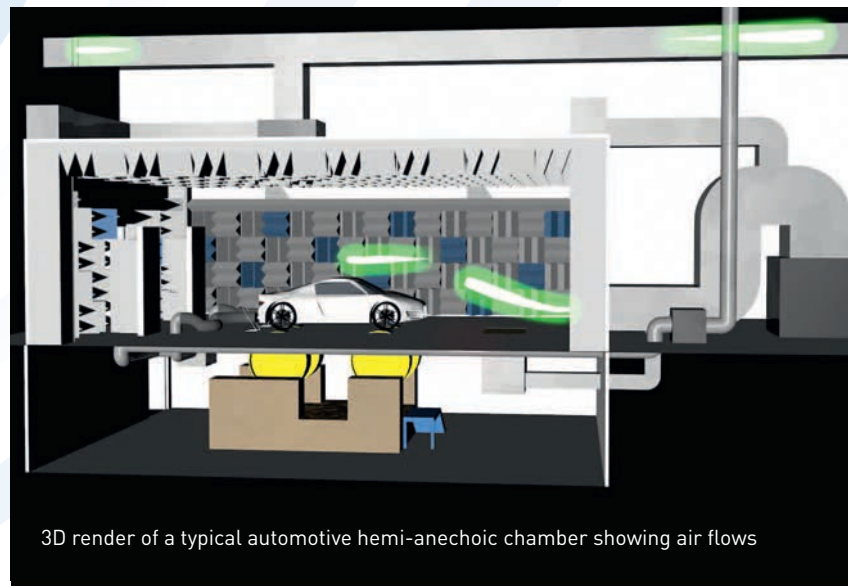

Mode/ Test No.	Air Re- Circ.	Qty. m <sup>3</sup> /s	Vehicle	Dyno.	Air Cond.	Exhaust Fan	Noise
1	Yes	1.25	Off	Off	On	Off	25dB(A)
2	Yes	3.50	Idle	Off	On	On	30dB(A)
3	Yes	6.00	Cyclic	On	On	On	35dB(A)
4	Yes	11.00	Cyclic	On	On	On	40dB(A)
5	No	11.00	Cyclic	On	On	On	45dB(A)
Manual	Yes	Variable	Variable	On	On	On	Variable
Purge	No	11.00	Off	Off	Off	Off	55dB(A)

Typical Ventilation Modes of Operation





## Typical Automotive Ventilation System Schematic

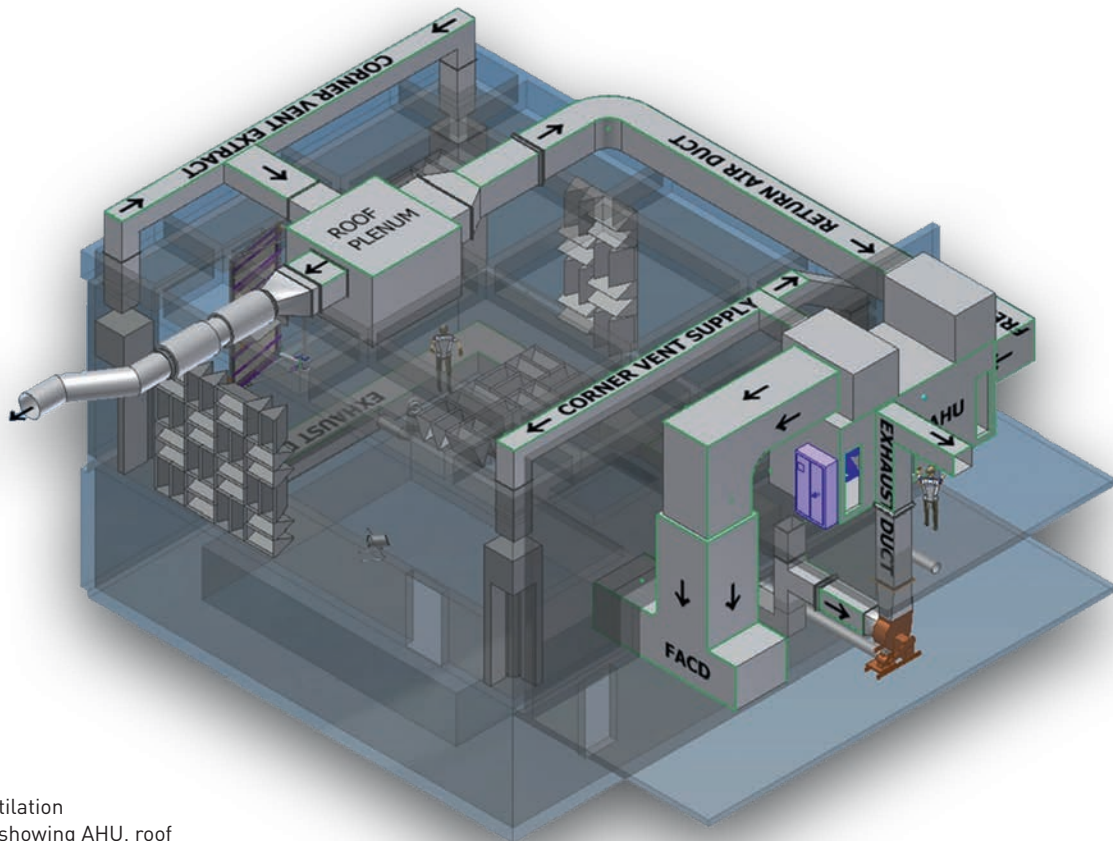

Typical ventilation schematic showing AHU, roof plenum re-circulation system and exhaust

### Mechanical Ventilation

There are five operating modes for a typical chamber ventilation system during vehicle testing plus additional plant and controls for exhaust, dynamometer cooling, 24 hour pit ventilation and localised spot cooling systems.

Operating modes are designed to match client test cycles, ensuring adequate heat removal at controlled sound levels.

Moving large volumes of air in to and out of a chamber for vehicle testing can be hazardous, however the IAC control system helps to minimise risks by including an emergency shut-down mode to suit the requirements of the client. Sensors for temperature and pressure plus feedback on damper and valve positions on both the air and mechanical systems mean the whole facility will be shut down in the event of an imbalance of pressure or unsafe levels of fumes. Safety systems can be altered for individual clients with specific requirements or tolerances.

The system allows different levels of access and control dependant on the experience of the user – more experienced test engineers can select a manual mode (via password override) where the user can adjust volumes and temperature set points. For peace of mind, the system will still prevent misuse via safety protocols.





## Forced Air Cooling Duct (FACD)

IAC focuses the ventilation system around the forced air cooling duct which allows the vent system to operate and cool even during the acoustic testing. This is due to the silencing of all the mechanical noise through a network of IAC duct attenuators.

## Exhaust Extraction

The IAC system allows for a variable speed exhaust fan that entrains cooler chamber air with the hot vehicle exhaust so as not to impose an unnatural load on the engine signature noise.

## Controls

A unique IAC control system has pre-programmed test modes as well as bespoke test regimes that can be enhanced throughout the life of the facility. The system is multi-lingual and fail safe.



Typical forced air cooling duct system in vehicle hemi-anechoic Chamber



IAC acoustic AHU during assembly

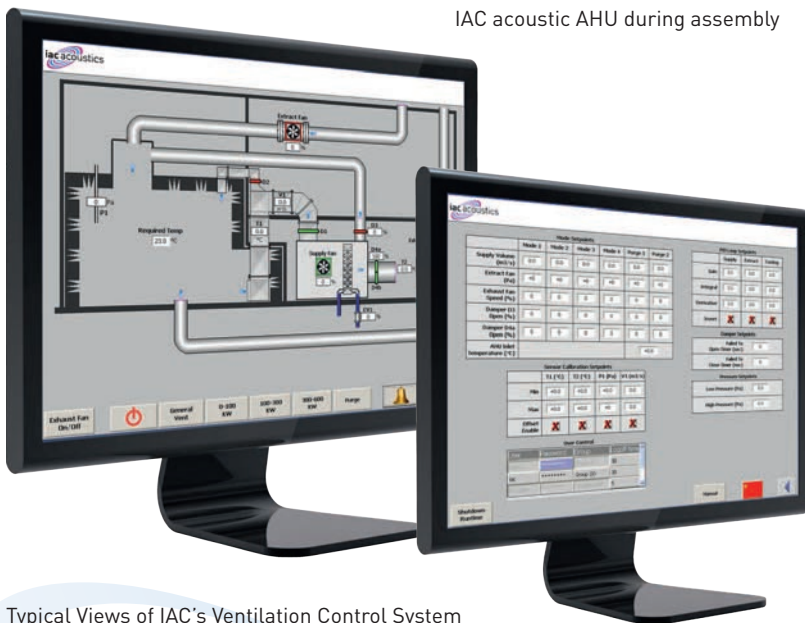

Typical Views of IAC's Ventilation Control System



Exhaust gas extraction installation in vehicle hemi-anechoic chamber

## Dynamometer Ventilation & Cooling

Due to the specialist nature of individual machines, this installation would normally be supplied by the chassis dynamometer company as it is dependant on whether the equipment is air or water cooled.

In either case, some nominal ventilation is required to move air in the dynamometer pit. IAC can incorporate a silenced air inlet with the necessary ductwork in order to keep background noise to an absolute minimum whilst conducting a test. If the ambient air is not conditioned enough, IAC can also add additional cooling.



IAC allows a one off single inlet centrifugal fan supply that may be configured to act as a supply or return air fan to the dynamometer pit. Final coupling geometry shall be part of the contract design evolution. In some instances, the chassis dynamometer supplier may specify water cooling for the machine – if part of IAC's supply, ambient temperature water is pumped around the system using a three-port-valve to mix sufficient chilled water to allow enough cooling without condensation.



## Optional Catalytic Converter Cooling – 'Spot Cooling'

For the purpose of directing cooling air to the catalytic converter, tyres and exhaust systems, a choice of either standalone fans in the chamber or ducting in the pit will supply conditioned test chamber air at smaller directed points under the vehicle.

If ducting in the pit is required, a fan in the pit supplies air to floor level ducts and points situated under the car to the left and right of the centre line. Each duct line usually has three separate tap-in connection points on top of the dynamometer flooring.

## 24 Hour Pit Extract

This is typically a 24hr running 'trickle' fan that extracts a small amount of air from the pit to ensure no build-up of noxious fumes.

## 'Pop-Up Flap'

In some instances, additional cooling of the test vehicle to speed up the time between tests is required. This can be done by diverting the existing cooling air, via dampers, ductwork, silencers and turning vanes to a pneumatic pop-up flap, positioned closer to the vehicle.

During testing, the flap must be in the down position as it would create an unwanted reflection in the anechoic space.

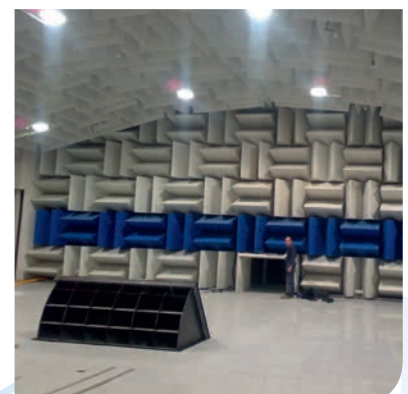



# Case Studies

Volvo (refurbishment)	42
Skoda	44
Lotus	46
Applus Idiada	48
Audi	49
Bajaj	50
BMW	51
British Gas	52
Delphi	53
Ford Australia	54
Ford UK	55
General Motors	56
Goodyear	57
Jaguar Sound Quality	58
Jaguar R&D Centre	59
Jaguar Airbag Facility	60
Mahle	61
Mando	62
Maruti Suzuki	63
Porsche	64
Ricardo	65
Rover	66
Skoda	67
Volvo (refurbishment)	68
Volvo	69
Customer List	70











Hemi-anechoic chamber refurbishment for Volvo Cars,  
Gothenburg, Sweden





---

## IAC Project – Volvo Cars

- Hemi-anechoic chamber upgrade
  - Removal of degraded mineral wool cubes and replacement with Metadyne® wedges
  - 12 weeks to complete
  - Complete ventilation system design and installation
- 



In 2005, IAC won a project with Volvo in Sweden for the refurbishment of a hemi-anechoic chamber. The chamber at the time had been in use for over 30 years, but was limited by the precision of measurements that could be gathered.

As part of the refurbishment, IAC removed all of the foam cubed acoustic linings from the walls and ceiling and replaced them with metal-faced Metadyne® anechoic wedges. This was the first anechoic chamber commissioned by IAC where multiple coloured wedges were used to reflect the corporate branding of Volvo. This new approach has now been adopted for many chambers which use Metadyne® wedges and has become a signature hallmark of IAC chambers. The new linings enhanced the overall acoustic performance of the facility and meant that a 100Hz cut-off frequency was achieved and certification under ISO 3745.

The original chamber posed some design challenges which IAC overcame in order to deliver the refurbished facility. Firstly the floor was of a grated design with the wall linings stretching below the floor level. No other absorption was present, meaning that the chassis dynamometer and other ancillary equipment were exposed. IAC replaced the floor with a solid Moduline™ based panel system which covered the entire footprint of

the facility. Access to the pit and dynamometer, despite the new solid floor was overcome by incorporating an acoustically lined hatch including a staircase.

In addition to the linings and floor, IAC also adapted the current ventilation system which was already in place by adding a pop-up flap to provide additional cooling and modified the corner vents and exhaust systems. The changes made to the ventilation system were to increase the overall acoustic performance of the facility through the use of IAC attenuators.

This project was the first of 2 anechoic facilities for Volvo at the same site, the second being an engine test cell including a new dynamometer for measuring noise and vibration.



making the world a quieter place



---

## IAC Project – Skoda

- 4x2 and 4x4 100Hz cut-off frequency hemi-anechoic chambers
  - Listening room
  - Psycho-acoustic laboratory
  - Modal analysis room
  - Chassis lifts in hemi-anechoic chambers
- 



“The fantastic new acoustic centre allows Skoda Auto engineers to not only save time and provide much more consistent tests, but has also provided a much more attractive and safe environment to work.”

Petr Pelant, Skoda Auto

The new Skoda Auto Acoustic Laboratories were completed in 2010 as a replacement of an old facility originally built in 1992. The new state of the art laboratories include two dynamometer hemi-anechoic chambers for 4WD and 2WD vehicles, a modal analysis room, component test room, psycho-acoustic laboratory and listening room.

Both of the hemi-anechoic chambers were equipped with dynamometers and in-ground vehicle lifts and used for passenger noise vibration harshness (NVH) road simulation tests including cabin, engine, intake, tyre and exhaust noise in addition to vibration measurements and powertrain mounting tests. The rooms were fitted out with IAC Metadyne® LF metal-faced wedges, providing an acoustic test space free from reflections in order to

comply with the stringent ISO 3745 standard for acoustic power measurement. This choice of absorbent lining with its improved durability, ensures a consistent test environment for the lifetime of the laboratories.

A challenge faced by the project was the provision of adequate vehicle cooling without impacting any acoustic measurements. This was solved by ventilating each room using an IAC Quiet-vent® duct attenuator system for minimal ambient noise in the chambers. Conditioned air is introduced into the test room via corner ventilation units and a forced air cooling duct at the front of the vehicle. A pop-up ventilation flap extracts the heated air and flexible exhaust collectors safely remove combustion gases from the test environment.

The modal analysis room is used to measure vibrations and the resulting emitted frequencies from sections of the body and chassis. This room was designed with IAC Varitone™ panels to control echo and reverberation. The component test room is also equipped with IAC Varitone™ panels and is used for testing the noise emitted from component parts such as the air conditioning system, window wipers, doors and windows. The psycho-acoustic laboratory and listening room use IAC Accutone™ panels, enabling listening tests for reviewing vehicle noise and sound quality assessments.





Skoda Auto Acoustic Laboratory facility  
in the Czech Republic





---

## IAC Project – Lotus Cars

- Refurbishment of existing facilities (both ESAC and VSAC)
  - IAC Metadyne anechoic wedges used in both chambers
  - Wedge basket doors
  - 70Hz cut-off frequency in both rooms
  - Modernised ventilation system
- 



Lotus Cars are a British manufacturer of sports and racing cars, famous for its Elise, Exige and Evora sports cars and for the highly successful Team Lotus in Formula 1. Lotus Engineering Limited is an offshoot of Lotus Cars, which provides engineering consultancy to third party companies primarily in the automotive industry. As well as their Head Office being in Hethel in the United Kingdom, Lotus also has engineering centres in the USA, Kuala Lumpur, Malaysia and Shanghai. With their main focus on four core engineering competencies: light weight architectures, efficient performance, electronic integrations and driving dynamics, Lotus Engineering strive to deliver first class consultancy to its third party companies. In order to do this, Lotus Engineering needed to provide incomparable facilities which include their vehicle semi-anechoic chamber and their engine semi-anechoic chamber.

IAC Acoustics recently won a project with Lotus Engineering for the refurbishment of their vehicle semi-anechoic chamber and engine semi-anechoic chamber. The old chambers had previously been in use for over 20 years, but were limited by the precision of measurements that could be gathered. As part of the refurbishment, IAC Acoustics removed all of the fibre-glass wedges and replaced them with Metadyne wedges, which were specified by the customer. This allowed for

a more accurate and reliable reading to come from the chambers. A number of IAC Acoustic products were used to enhance the overall acoustic performance of the facility. Bespoke wedge basket doors were used on both chambers to fit the existing openings and incorporate a seamless acoustically absorbent chamber lining. IAC Acoustics had to match the existing performance of both chambers so had to carry out a pre and post commission service for Lotus Engineering. The project took around three months to complete.

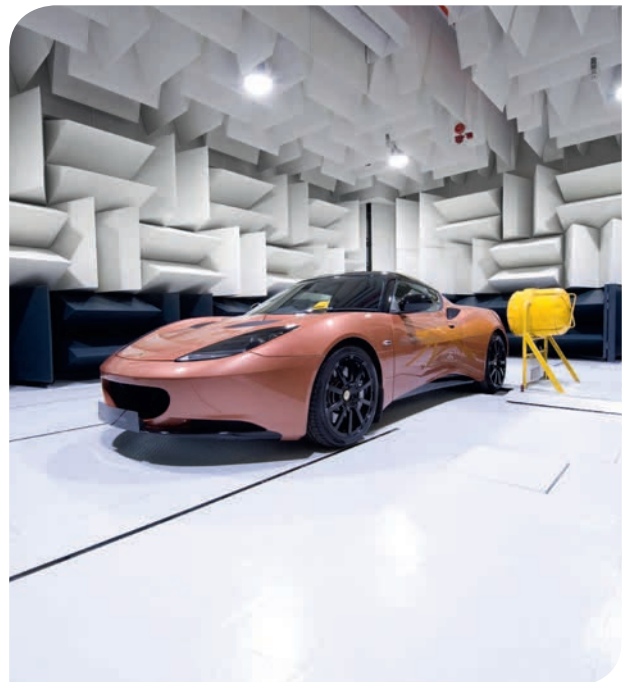



Lotus Acoustic Laboratory facility







### Applus+ IDIADA Automotive Test House

- Turnkey design and build ISO 3745 hemi-anechoic chamber
- 50Hz cut-off frequency
- Metadyne<sup>®</sup> LF wedges
- Curved hemi-anechoic roof
- Background 22dB(A)
- Temperature control 24+/-1 °C
- Reversible ventilation flow

#### Dynamometer

- 2WD – 2 motors
- 72" rolls

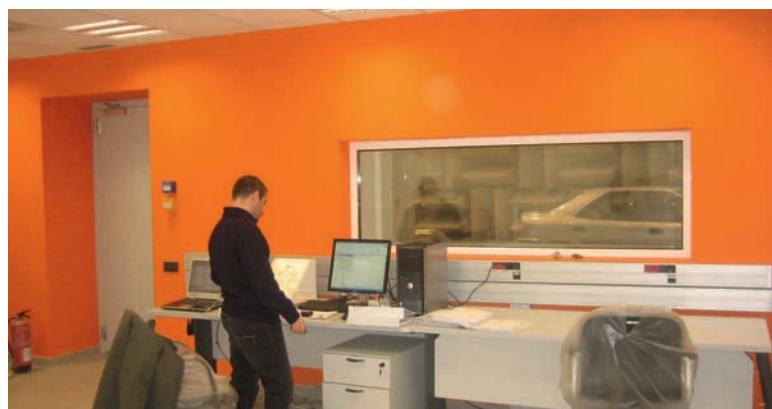





Audi



### Audi R&D Acoustic Centre

- 2 hemi-anechoic chambers, each designed with IAC Planarchoic™ flat wall panels and Metadyne® wedges in the ceiling to increase the amount of absorption
- 80Hz cut-off frequency
- ISO 3745 compliant
- Many items of ancillary equipment such as cranes, large IAC Noise-lock® vision panels and test stands

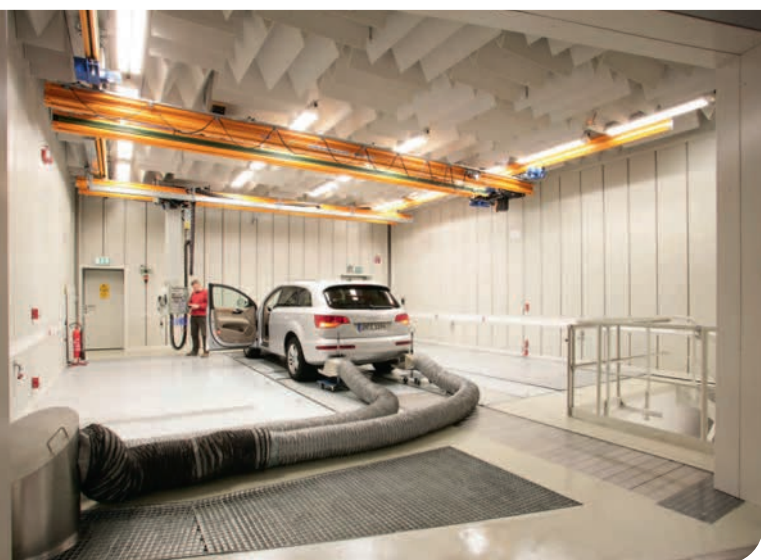





## Bajaj Auto Acoustic Centre

- Full facility design, stand alone new building and IAC pass-by hemi-anechoic chamber
- IAC Metadyne® LF wedges
- IAC Noise-lock® acoustic doors
- Unique IAC curved roof design
- Facility built to carry out motorcycle and passenger car NVH testing including road simulation tests, cabin noise, engine compartment, intake and exhaust noise, vibration measurements, powertrain mounting system tests and tyre noise tests
- IAC Quiet-vent® ventilation and lighting systems
- 4x2 chassis dynamometer

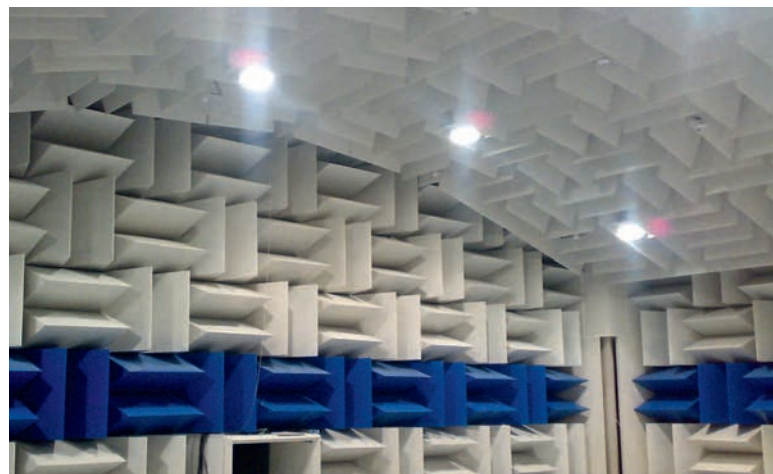



## BMW Hams Hall Production Plant

- First full engine production facility built by BMW outside of Germany or Austria
- IAC provided Noise-lock® acoustic doors for a number of engine test cells
- All doors exceeded the 56dB noise reduction set by BMW
- All doors had a 1 hour fire rating
- 8 over-sized heavy duty Z-frame doors used for moving equipment and test stands freely
- 8 personnel access doors all equipped with vision panels







### British Gas Research Centre

- Largest natural gas engine test facility in Europe
- 1 environment test chamber with chassis dynamometer
- 5 engine test cells
- All test cells lined with IAC Noise-lock® modular panels and high performance acoustic doors
- Unique door within a door at the entrance to the large test chamber to allow both vehicle and people access







## Delphi Automotive Test House

- Hemi-anechoic chamber used for vehicle NVH testing
- Fully anechoic chamber used for measuring noise emissions for automotive component parts
- IAC Metadyne® anechoic wedges to both facilities
- IAC Noise-lock® acoustic doors to both chambers
- IAC Quiet-vent® ventilation system

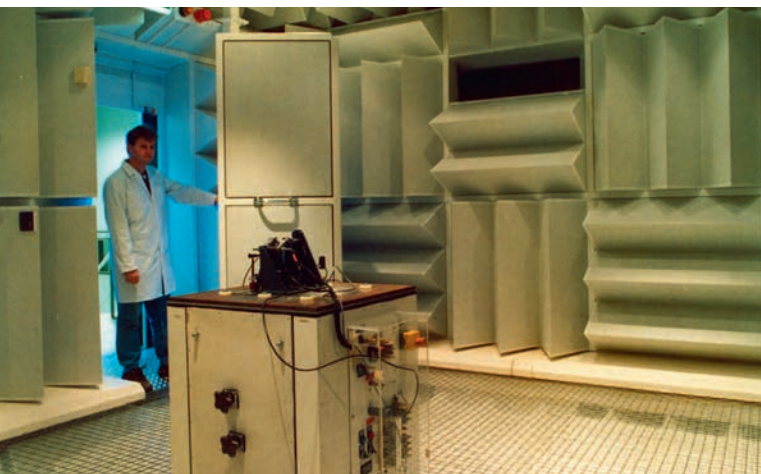





## Ford Automotive R&D Centre

- Turnkey design and build
- ISO 3745 hemi-anechoic chamber
- 50Hz cut-off frequency
- Metadyne® LF wedges
- 17.1m x 13.5m x 5.5m high
- Curved hemi-anechoic roof
- Background noise 20dB(A)
- Temperature control 24+/-1°C

### Dynamometer

- 4WD, 250km/h
- 72" rolls; 12,000 N (21,000 N)
- 48dB(A) at 100 km/h

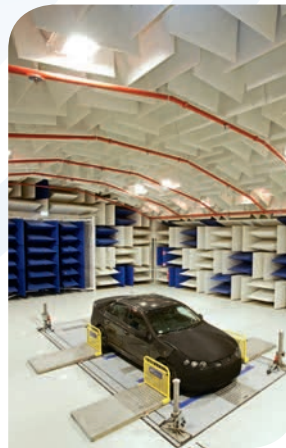





### Ford UK Acoustic Centre

- 4x4 chassis dynamometer
- Hemi-anechoic chamber lined with fibreglass wedges
- 100Hz cut-off frequency
- Over 1900 anechoic wedges used for the installation
- ISO 3745 compliant
- 12m x 9.5m x 4.3m high







## GM Proving Ground Development Centre

- 9 VSAC's, each with chassis dynamometers and 100Hz cut-off frequency
- Pass-by VSAC with 50Hz cut-off frequency and chassis dynamometer
- 6 VSAC's with a cut-off frequency of 100Hz
- 3 full anechoic chambers for component testing
- 3 reverberation rooms each with a 100Hz cut-off frequency for component testing and lined with IAC Hardliner™ panels
- Metadyne® LF wedges in all anechoic chambers
- Hot and cold rooms for climatic component testing





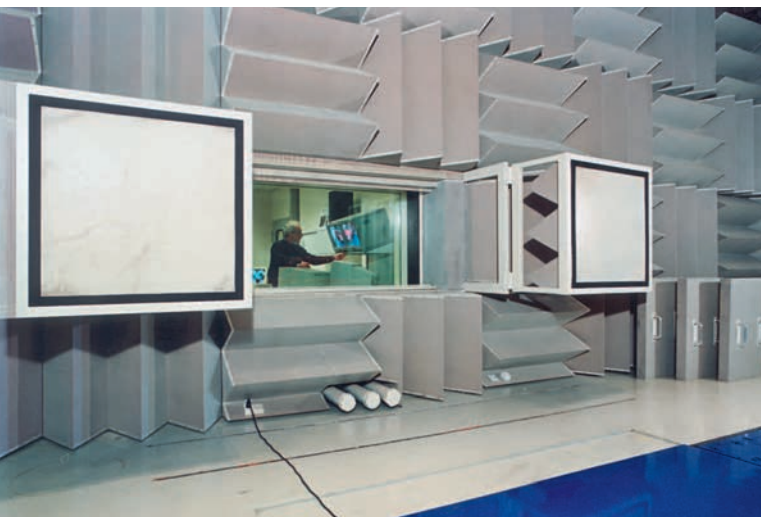

## Goodyear Acoustic Test Centre

- Hemi-anechoic chamber
- IAC Metadyne® LF wedges
- ISO 3745 compliant
- IAC Noise-lock® acoustic doors
- Chamber used to test the noise emissions from different size tyres
- IAC Quiet-vent® ventilation and lighting systems
- 4x2 chassis dynamometer





## Jaguar Cars R&D Centre

- Sound quality facility
- Constructed from IAC Moduline™ panels
- Structurally isolated listening room built to NR20 – radio studio standards
- IAC Quiet-vent® ventilation system
- Provides a uniquely quiet environment for assessing a wide range of live and recorded vehicle sounds
- Listening ‘juries’ are asked to comment on various noises which helps Jaguar to create vehicles that have the right sound identity and personality







## Jaguar Cars R&D Centre

- Turnkey design and build
- ISO 3745 compliant
- VSAC hemi-anechoic chamber
- 60Hz cut-off frequency
- 17m x 13.5m x 5.5m chamber
- Metadyne® perforated, metal-faced wedges
- Full M&E installation
- Ventilation and vehicle exhaust systems
- Full project management from site analysis, to construction, commissioning and final site landscaping
- 4-wheel drive chassis dynamometer
- Spacious control room with CCTV





## Jaguar Cars Automotive R&D Airbag Test Facility

- 14m x 11m x 5m acoustic test facility
- Housed within component testing building
- Protects workers from 140dB(A) air bag firing noise
- For filming and measurement of air bag performance
- Adjacent control room with:
  - IAC Noise-lock® acoustic windows
  - 3m<sup>2</sup> sliding acoustic door
  - IAC Varitone™ sound-absorptive wall panels
- Access walkways
- Ventilation silencers







## Mahle (previously Tennex Europe) Automotive Component R&D Centre

- Turnkey design and build
- ISO 3745 hemi-anechoic 'white noise' test room
- Ambient noise level NR20
- 125Hz cut-off frequency for testing uninstalled components
- ISO 3745 VSAC hemi-anechoic test room
- Ambient noise level  $\leftarrow 35\text{dB(A)}$
- 100Hz cut-off frequency for testing vehicle-installed components
- 2-wheel drive acoustic chassis dynamometer
- All M&E, lighting, fire suppression, vehicle exhaust and gas detection systems







## Mando Automotive Test Facility

- Single wall design hemi-anechoic chamber
- 125Hz cut-off frequency
- Metadyne® anechoic wedges
- Adjoining control room
- Quiet-vent® ventilation system keeps background noise at below 30dB(A) even when running at 10m<sup>3</sup>/s

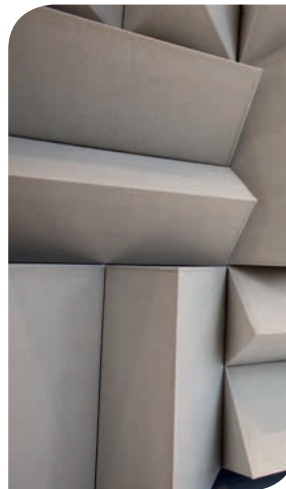



## Maruti Suzuki Acoustic Centre

- Full facility design, standalone new building and IAC (VSAC) hemi-anechoic chamber
- IAC Metadyne® LF wedges
- IAC Noise-lock® acoustic doors
- IAC Quiet-vent® ventilation and lighting systems
- 4x4 chassis dynamometer
- Facility built to carry out passenger car NVH testing including road simulation tests, cabin noise, engine compartment, intake and exhaust noise, vibration measurements, powertrain mounting system tests and tyre noise tests





PORSCHE



## Porsche Automotive R&D Centre

- Vehicle fully-anechoic chamber upgrade
- New fibreglass wedges
- Grate floor
- Basket doors
- Ventilation inlets
- Engine testing anechoic chamber upgrade
  - Octagonal configuration
  - Grate floor
  - Basket doors
  - Ventilation inlets

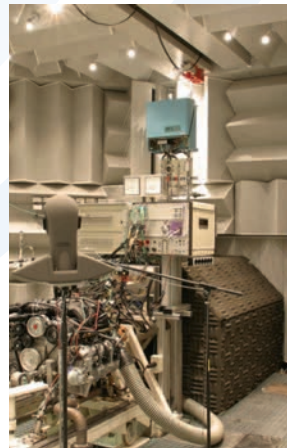



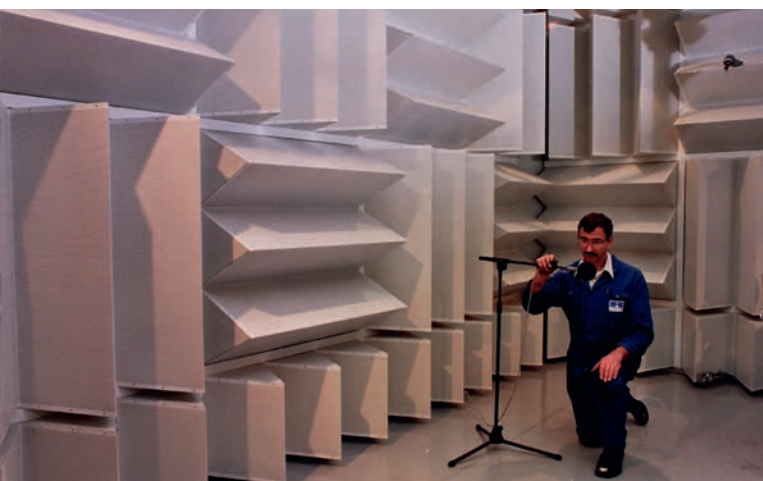
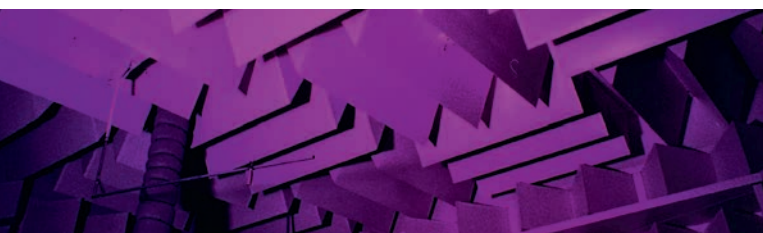

## Ricardo Automotive Test House

- Conversion of foam-lined fully anechoic chamber to hemi-anechoic with Metadyne® wedges
- 100Hz cut-off frequency
- Solid floor
- Palletised engine installation
- Downtime reduced from 7 days to 1
- Acoustic performance maintained
- Bright, easy-maintenance working environment





## Rover Group Automotive R&D

- For Land Rover
- Replaced damaged foam wedges at vent outlets
- Duct cleaning
- Rebuild VSAC hemi-anechoic chamber
  - 100Hz cut-off frequency
  - ISO 3745 compliant
- 350m<sup>2</sup> of Metadyne® perforated, metal-faced wedges

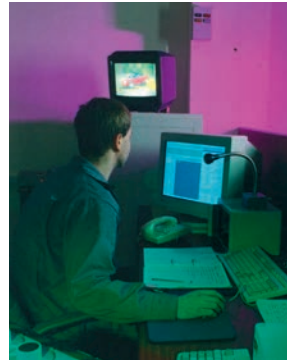





## Skoda Auto Acoustic Centre



- Replacement of old hemi-anechoic chamber built in 1992
- Two IAC VSAC hemi-anechoic chambers
  - One 4x4 hemi-anechoic chamber
  - One 4x2 hemi-anechoic chamber
  - Complete “room in room” construction
- IAC Metadyne® wedges
- IAC Noise-lock® acoustic doors
- IAC Quiet-vent® ventilation and lighting systems
- Modal analysis room has a floating floor and equipped with the IAC Varitone™ panels
- Component test lab equipped with the IAC Varitone™ panels, used for noise tests of wipers, doors, windows, etc.





### Volvo Automotive R&D Centre

- 30 year-old hemi-anechoic chamber upgrade
- Removal of degraded mineral wool cubes
- Replacement with Metadyne® metal-faced wedges
- Accent colour to create attractive corporate statement
- Enhanced acoustic performance
- 12 weeks to complete

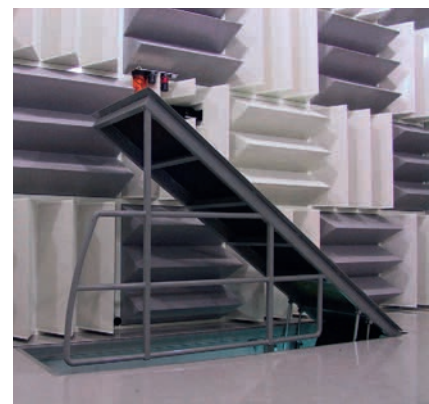





## Volvo Cars R&D Centre

- Extensive consultation on sound, vibration and ventilation
- Acoustic equipment supply/installation for VSAC with 60Hz cut-off frequency
- 19m x 13m and 5.3m high
- 700 Metadyne® LF anechoic wedges
- Large vehicle access door and personnel door – both of wedge basket configuration
- Forced air cooling duct (FACD)
- Four special corner vents
- Large ceiling anechoic air outlet duct



## Automotive Acoustic Test Facility International Customer List

Customer	Description	Location	Customer	Description	Location
Aberdeen Proving Ground	M H	USA	Ford Motor Company	Mi H	USA
Airic	M P	Iran	Ford Motor Company	M V ✱	Australia
American Axle	M H	USA	Ford Motor Company	M H	USA
Alpine	Mi M	Germany	Ford Motor Company	M H	USA
Arcelic	M H	Turkey	Ford Motor Company	Mi H	UK
Artc	M H	Taiwan	Ford	Fg H	UK
Arvin	M H	USA	Ford Rawsonville	M H	USA
Arvin Muffler	M H	USA	Georgia Tech	M A	USA
Arvin Muffler	M H	USA	GIF	M V	Germany
Arvin N.A.	Mi A	USA	GM Corporation	M H	USA
Audi	M H	Germany	GM Lansing	M H	USA
Audi	M F H	Germany	GM Truck & Bus	M V	USA
Audi Ingolstadt	Mi H	Germany	GM Brazil	M V	Brazil
Bajaj Autos	M P	India	GM Flint	M H	USA
Bar F1	M E	UK	GM Milford	M H	USA
BMW	E	UK	GM Saginaw	M H	USA
Bosch Auto	M H	USA	Goodyear	M V	Luxembourg
Bosch Automotive	M H	USA	Harley Davidson	M P	USA
Bridgestone/Firestone	M V	USA	Harman Consumer Group	Mi A	USA
BYD (Build Your Dreams)	M P V L	China	Harman International	Mi H	USA
Burke E. Porter	Mi A	USA	Harman International	M H	USA
Ceeva	M V	France	Harman Motive	Mi H	USA
Cetecom	Mi A	Germany	Harman OEM Group	M H	USA
Chrysler Motor Corporation	M V	USA	Harman Becker UK	Mi A	UK
Chrysler Motors	M V	USA	Honda F1	M E	UK
CMI-Ricardo	Mi E	USA	Honda	F H	USA
Coltec Automotive	M A	USA	Honda America	F H	USA
Continental	F V	USA	Honda America	M H	USA
Creos	M V	France	Honda UK	M V	UK
Daewoo	M H	USA	Hyundai Motor	M A	USA
Dana Corp.	M H	USA	Hyundai Motor	Mi A E	USA
Deere & Company	M H	USA	Idiada	M V ✱	Spain
Deere & Company	M H	USA	ITT Automotive	F H	USA
Deere & Company	M H	USA	ITT Automotive	F H	USA
Deere & Company	M H	USA	ITT Rochester	M A	USA
Deere & Company	M H	USA	IMS Morat + Söhne	M H	Germany
Delphi Automotive	Mi A	USA	Ivensys	R	USA
Delphi Int. Sys.	M H	USA	Jaguar	L	UK
Delphi Products	M H	Luxembourg	Jaguar	M V ✱	UK
Delphi Products	M A	Luxembourg	Katri	M V	Korea
Delphi Products	M H	Germany	Kampmann	M H	Germany
Dow Automotive	M H	USA	Karmann	M H	Germany
Faital	M H	Italy	Kolano & Saha	M A	USA
FEV Engine Tech	M H	USA	Kuzoi Motors	M H	Taiwan
Fiat	M A	Italy	Kwang Motors	M H	USA
Fisa	M H	Italy	Lear Corporation	M H	USA
Ford Motor	M A	USA	Land Rover	Mi V	UK
Ford Motor Company	M V x12	USA	Lombard Co.	M H	USA

Customer	Description	Location
Lotus	M H V	UK
Lotus	M H E	UK
Magna Corporation	Mi H	USA
Mando	M H	USA
Massey Ferguson	M H V	France
Maruti Suzuki	M H V L	India
McLaren F1	M H E	UK
Merloni	M H	Italy
Methode Electronics	M	USA
Monroe Auto	Mi A	USA
Monroe Auto Equipment	Mi A	USA
Monroe Auto Equipment	Mi A	USA
Motor Products	Mi A	USA
MTS	M F H	USA
Nissan European Technology Centre	M H V	UK
Nissan European Technology Centre	Mi H V	UK
Nissan	M H E	Spain
Nissan	M H Q	USA
Opel	M H V	Germany
Opel Russelsheim	M H	Germany
Perstorp	M H V	USA
Porsche	M A E	Germany
Porsche	M H V	Germany
Renault	M H V	France
Ricardo	M H E	UK
Ricardo	M H E	USA
Rousch Anatrol	M H V	USA
Rousch Anatrol	M H	USA
Rousch Anatrol	F H	USA
Rover	M H V	UK
Rover	SR	UK
Rolls Royce Motor Cars Ltd	M H SR	UK
Sanden	M H V	France
Schenck Pegasus	M H V	USA
Schenck Pegasus (Ford Motor Co.)	M H	USA
SDRC	M H SQ	USA
Sebring	M H V	Austria
Siemens Corporation	M H	USA
Siemens Corporation	M H V SQ	UK
Siemens Ag, Bad Neustadt	M	Germany
Siemens Munich	M H	Germany
Siemens Kamplintfort	M A	Germany
Siemens Bocholt	M H	Germany
Siemens Ulm	M A	Germany
Siemens Production Technology	M H	Germany
Siemens Beijing	M H	China
Sika Industry	M A	USA
Skoda	M H L SQ	Czech. Rep.

Customer	Description	Location
Sverdrup Technology Inc.	M	USA
Tennex Industries	M H V ✪	UK
Toyota	M H V	USA
TRW	M H Q	Germany
US Army	M H	USA
Valeo	M H Q	USA
Valeo	M H Q	USA
Valeo Wiper Systems	M H Q	USA
Valeo	M H Q	France
Visteon (Ford)	Mi A	UK
VW Wolfsburg	Mi A	Germany
Volvo	M H V	Sweden
Volvo	M H E	Sweden
Volvo	M H V	Sweden
Volvo Penta	M H E	Sweden

## Key

- Metadyne® Wedges
- Microdyne® Foam Wedges
- Microdyne® Fiberglass Wedges
- Planarchoic™ (flat) Panels
- Full Anechoic Chamber
- Hemi-anechoic Chamber
- Vehicle Semi-anechoic Chamber (VSAC)
- Engine Semi-anechoic Chamber (ESAC)
- Pass-by Chamber
- Listening Room
- Quiet Room
- Shake & Rattle Facility
- Sound Quality Room
- Reverberation Chamber
- Turnkey Project



# Industrial & OEM Facilities







**Power  
Generation**

**1-877-769-7669**

[www.cumminspower.com/rental](http://www.cumminspower.com/rental)



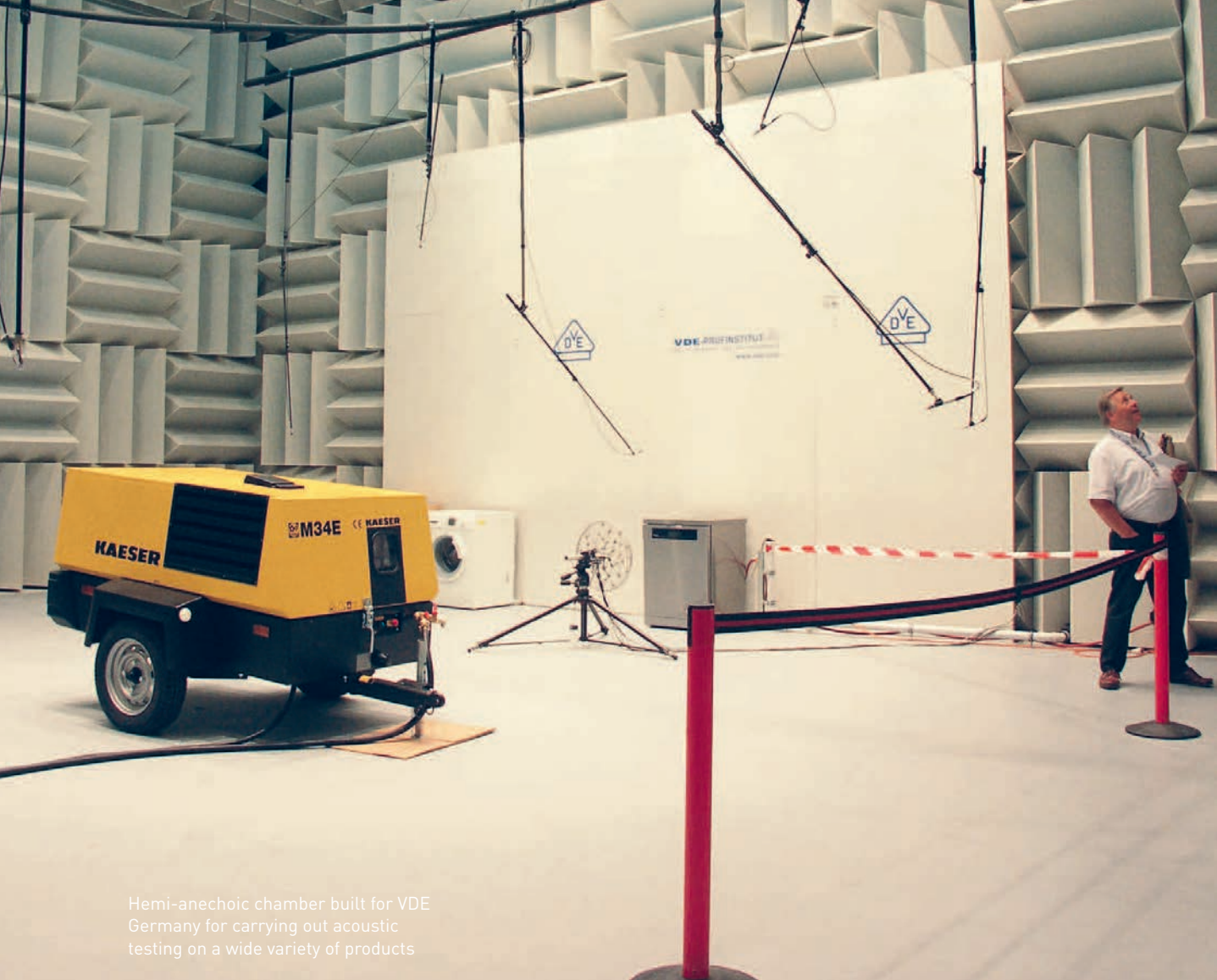

Hemi-anechoic chamber built for VDE Germany for carrying out acoustic testing on a wide variety of products

### Acoustic Testing for Industrial OEMs

IAC has supplied some of the world's best brands with various kinds of acoustic test facility. From computer components to large diesel engines and generators, IAC can supply a solution to providing a certified facility for carrying out acoustic measurements and tests. From supplying acoustic lining packages to a complete turnkey facility, IAC can provide a cost effective solution to your testing requirements.

### Types of Facility Provided

Typical facilities provided are anechoic test rooms or reverberation chambers and are predominantly used for certifying products and carrying out R&D. In addition to providing larger facilities, IAC can also provide compact anechoic chambers for testing small devices and components for the electronics industry.

“  
**IAC is the largest  
supplier of certified  
acoustic test facilities  
in the world.**  
”

### IAC Turnkey Service

In addition to a range of turnkey testing facilities for the automotive sector, IAC will also provide a complete facility to OEM suppliers, including all civil and construction works plus the supply of any specialist ancillary equipment that may be required.

## IAC Turnkey Chambers

Where suitable, or if a complete solution is required by the client, IAC will provide a turnkey facility including all civil and construction works. IAC will also work closely with clients to aid with local authority or planning issues concerning the site.

By opting for a turnkey service from IAC, this not only minimises risk, but also ensures that the facility will accommodate the most suitable acoustic package and perform to the best possible standard.

For large chambers that are designed to accommodate engines such as diesel generators, IAC will design a bespoke mechanical and electrical system to ensure the correct amount of air is passed into the chamber and all toxic gases are expelled to the atmosphere.







Hemi-anechoic chamber for OCE for testing printers and other office machines

## Features and Options

In addition to providing the acoustic treatments in order to create an anechoic facility, IAC is also able to supply the following products / services:

- Acoustic doors, including:
  - Single leaf
  - Double leaf
  - Sliding
- Wedge basket
- Silent ventilation system
- Vibration isolation
- Cable/removable floors for fully anechoic facilities
- Complete facility commissioning service

making the world a quieter place

## IAC Microdyne® Mini Anechoic Chambers

IAC mini anechoic chambers provide a compact, low-cost anechoic test environment in which manufacturers of small devices and components can accurately measure the noise emissions of their products.

- Custom-designed and manufactured to almost any size/specification
- High performance – typical cut-off frequency of 300Hz
- Low cost (compared to 'walk-in' rooms)
- Fully assembled, ready to use
- Ideal for both product development and quality control testing
- Hundreds in use throughout the world
- Larger anechoic and hemi-anechoic test rooms also available
- BS EN ISO 9001 quality registered

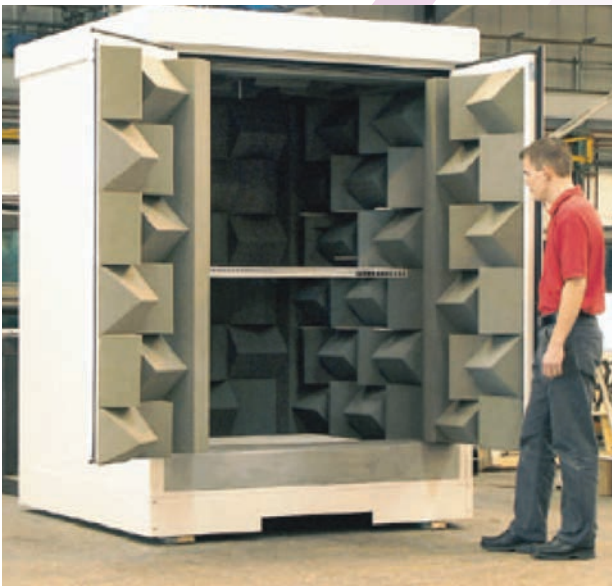

Microdyne® mini anechoic chambers are designed and constructed by IAC to accommodate the specific products and test methods of individual customers. The size of the unit is calculated to take account of how and where it will be used. Optional features also include:

- Single or double-leaf acoustic doors
- Mesh shelves and hangers to support the test subject
- Wall penetrations for cables, wires etc – in any chosen position
- A variety of colours for foam wedges and exterior finish

## Typical Uses

IAC mini anechoic chambers are ideal for testing and developing a wide range of products, including:

- Telecoms equipment, including mobile phones
- Speakers and other audio/visual devices
- Small household appliances
- Small motors and fans
- Computer disc drives
- Medical instruments
- Automotive components



Example of Microdyne® mini anechoic chamber during use

soft





## IAC Project – Cummins Power Generation

- Turnkey project
- Hemi-anechoic chamber
- 50Hz cut-off (main chamber)
- ISO 3745 compliant
- IAC Quiet-Vent® silent air handling system moves 105m<sup>3</sup>/s of air
- 150Hz cut-off (small chamber)



Cummins Power Generation is a subsidiary of Cummins Inc., with headquarters in Fridley, Minnesota. The “Acoustic Test Facility”, which is the largest of its kind in the world, comprises of two separate hemi-anechoic chambers, a control room and preparation area.

The new facility was built to carry out precise acoustic measurements around generator sets of all sizes. Being able to take consistent measurements has enabled Cummins to pinpoint sources of noise around a generator set and ultimately develop quieter systems for generators in the future. Prior to the new 23,000 square foot building, acoustic testing had been carried out outdoors, which made repeatable testing an issue and also caused unwanted noise to neighbouring communities. The new hemi-anechoic chambers not only make the testing space acoustically accurate, but also act to contain noise within the building. This means that testing can be carried out for longer periods, increasing productivity.

As turnkey providers, IAC was responsible for all aspects of the design and build. IAC handled all mechanical, electric, acoustic and civil aspects of the job and utilised all of IAC’s extensive expertise across a whole range of product areas, including acoustic louvres, Quiet-vent® silencers, Noishield™ acoustic panels, AHUs, Metadyne® wedges and Noise-lock® acoustic doors.

With the capability of testing large generator sets that produce up to 3.3MW of electricity, and with the ability to expand to handle generator sets up to 4.4MW in the future, IAC worked very closely with Cummins on designing the air handling and mechanical installation. The system, which incorporates IAC acoustic air handling units, plenums and duct silencers, allows up to 105m<sup>3</sup> per second of air to travel into and out of the main chamber. Moving such a volume of silenced air proved a real challenge, but now installed, the whole system can be managed by a single operative via an IAC designed control system.







Acoustic Testing Centre at Cummins Power Generation headquarters, Fridley, Minnesota





Turnkey hemi-anechoic chamber and reverberation room at Engineering Centre of Excellence for FG Wilson in Belfast, Northern Ireland

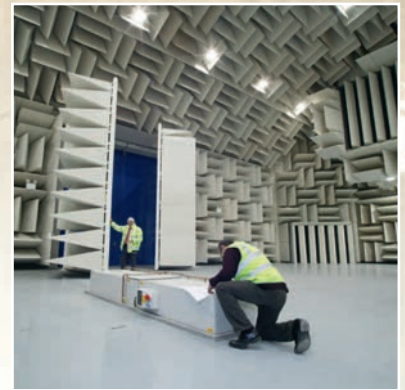

---

## IAC Project – FG Wilson

- Turnkey hemi-anechoic chamber
  - 25Hz cut-off frequency
  - 100Hz reverberation chamber
  - ISO 3745 compliant
  - ISO 3741 compliant
  - IAC Quiet-vent® silent air handling system moves 100m<sup>3</sup>/s of air
- 



IAC built one of the company's largest ever anechoic facilities for testing diesel generators. The anechoic chamber provides a state of the art engine test facility for FG Wilson in Northern Ireland, part of the world-renowned Caterpillar Group.

FG Wilson is one of the largest manufacturers of diesel and gas generator sets in the world. The new facility, called the Engineering Centre of Excellence aids manufacturing and R&D at the site, with gensets destined for both the EU and USA marketplace.

Located right in the heart of the local community in Larne, the company's previous open air grass 'noise circle' testing facility, was causing noise nuisance. The new facility eliminates virtually all environmental impact by keeping noise in, and also provides a perfect 'repeatable' sound testing environment, keeping wind and weather interference out.

The project took just 12 months to complete, has two components: a hemi-anechoic chamber designed with 60Hz cut off and 40Hz cut off – to meet both UK and USA regulations; and a reverberation chamber with a 100Hz cut-off frequency.

The site conforms to all international requirements, meeting ISO 3744, ISO 3745 and the EU standard for the CE mark.

The grand opening of the Engineering Centre of Excellence, was hosted by Mark Sweeney, Managing Director of FG Wilson. Such was its economic significance for the area that the ceremony was also attended by Angela Smith, Minister for Enterprise, Trade and Investment as well as Bill Rohner, Vice President of the Electric Power Division at Caterpillar and John Leslie, Chairman of Invest Northern Ireland.



making the world a quieter place



---

## IAC Project – York International

- Turnkey project
  - Hemi-anechoic chamber
  - 50Hz cut-off frequency
  - Metadyne® anechoic wedges with humidity resistant infill
  - Track and trolley equipment conveyance device
- 

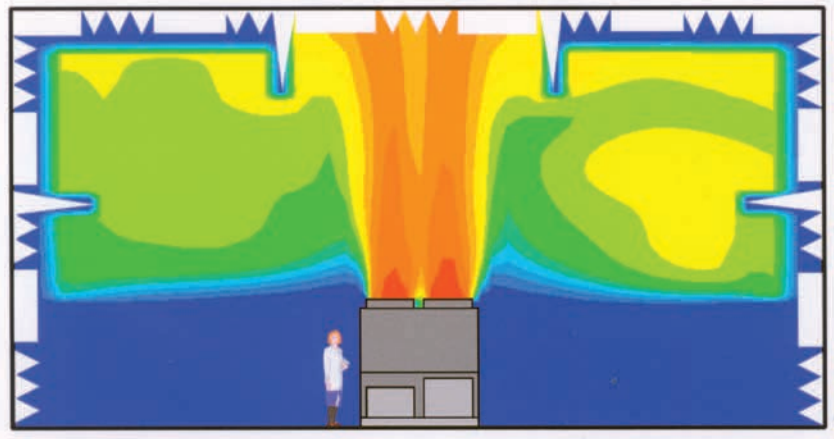

When commissioned for York International, it was Europe's largest and most sophisticated test facility for measuring the thermal and acoustic performance of air conditioning and refrigeration equipment. The facility has a 17m x 14m x 7m high hemi-anechoic room – with a cut-off frequency of below 50Hz – in which products, such as chillers and heat pumps, can be tested at temperatures ranging from 0 to 50°C. The facility is used to certify the sound levels and power output of York International products up to 750kW, in accordance with internationally recognised Eurovent standards. It is also used for developing new products.

IAC's contract covered every aspect of the new test facility's design and construction, from geotechnical site surveys and groundworks to the main building structure, internal fit-out, all mechanical/electrical services and control systems and a track-and-trolley device for conveying items of equipment in and out of the test space. In addition to the hemi-anechoic test room, the facility has a 6m x 4m control room, plant room and equipment preparation bay.

The project created several major engineering challenges for IAC. For example, it was crucial that temperature, humidity and airflow inside the hemi-anechoic room could be very precisely controlled to satisfy Eurovent test

requirements. An actual (measured) air temperature tolerance of below +/- 0.1°C was achieved, with humidity controlled to within 5%. The facility has a cooling capacity of over 1.1MW and a heating capacity of 750kW. Its air movement system consists of four separate IAC air handling units (AHU's), delivering a total airflow of over 100m<sup>3</sup>/s. Both the AHU's and the facility's test and support plant, air conditioning, lighting etc draw their power from a brand new 1.6MW supply.

IAC also adapted the Metadyne® metal-faced anechoic wedges covering the walls and ceiling of the test room to withstand extreme fluctuations in temperature and humidity. The usual wedge infill material – which might have become damp and prone to sagging – was replaced with a new, moisture-resistant composite.







 **YORK**<sup>®</sup>  
BY JOHNSON CONTROLS

Turnkey hemi-anechoic chamber facility for York Chillers  
(Part of Johnson Controls), Essex, UK





## AMD Research & Development Facility

- Hemi-anechoic chamber
- 100Hz cut-off frequency
- Ambient noise level inside the chamber of  $\approx 10$  dB(A)
- Double-wall construction
- High acoustic specification as site is very close to Austin-Bergstrom International Airport with aircraft taking off over the site each day
- Chamber used for testing computer cooling fans

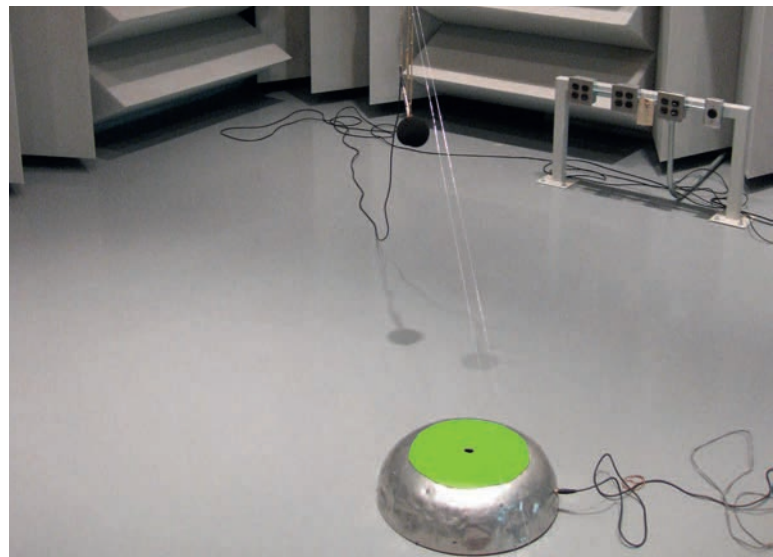



### Bergische University Wuppertal R&D Acoustic Test Facility

- New anechoic chamber with  $\leftarrow 200\text{Hz}$  cut-off frequency
- Within existing traditional brick-built construction
- Lined with BASOTECT Melamin sound absorbers
- Ability to recreate diverse sound environments
- Leading German centre for 'noise elimination' (ANC) research
- Facilitates the testing of infant incubators
- Valuable revenue earner for the university as the space can be rented out to commercial clients





## FG Wilson Engineering Centre of Excellence

- ISO 3745 compliant hemi-anechoic chamber with 25Hz cut-off frequency
- LF Metadyne® wedges
- ISO 3741 275m<sup>3</sup> 'skew wall' concrete reverberation chamber, 100Hz cut-off
- Certified for testing in compliance with EN2000/14 and SL2001/1701
- Four IAC acoustic air handling units (AHU's) provide 100m<sup>3</sup>/s through corner ventilation ducts
- Airflow can be controlled to supply cooling air at any position
- Waste heat (up to 3.6MW) expelled through high level silenced outlet duct and silencer at one end of the building
- Roof mounted, coupled exhaust removes harmful gases







## Cummins Power Generation Acoustic Testing Centre

- **50Hz Hemi-anechoic Chamber**
  - ISO 3745 – 50Hz at 10m
  - ISO 3744 – 50Hz over 600m<sup>2</sup>
  - ISO 6798
  - ISO 8528-10
  - EEC 200/14
  - Background noise levels NC20
- **Genset Range**
  - 1kW to 3.3kW
  - Infrastructure for 4.4MW
  - External ambient range -24°C to +31°C
- **Mechanical Plant**
  - 103m<sup>3</sup>/s to NC35 removing 3.3MW waste heat
  - 4.4MW load banks
  - LV supply 13.8kVA
  - Electrical plant – bus bar 6,000 amp
  - Heating 600kW
  - Cooling chillers 800 Tons
  - Fuels – gas, diesel, JP8, natural gas and propane





## Cummins Power Generation Acoustic Engine Cell

- ISO 3745 compliant
- Hemi-anechoic chamber with 150Hz cut-off frequency
- LF Metadyne® wedges
- Used for testing small generator engines

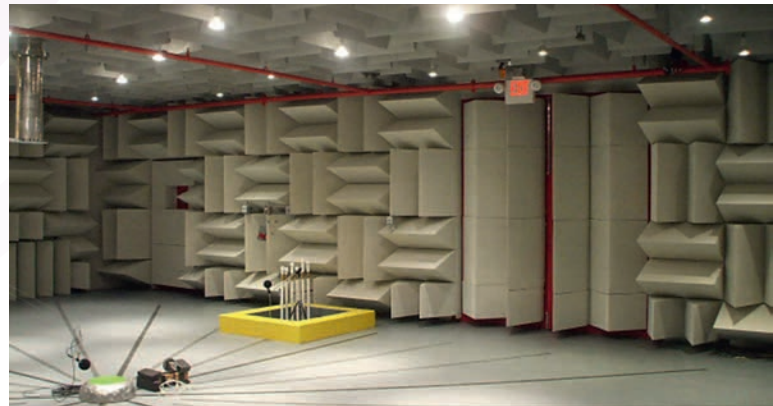

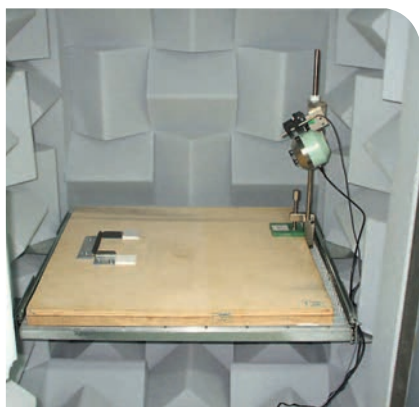
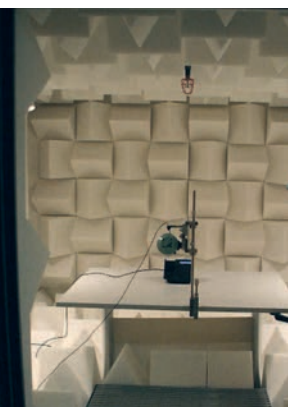

### Microsoft R&D Facility

- 2 mini anechoic chambers
- 2 fully anechoic chambers, each with a 250Hz cut-off frequency and identical acoustic performance
- ISO 3745 compliant
- Fire retardant foam wedges
- Fully anechoic chambers have integrated height adjustable test object tables, wire mesh protection on doors and custom cut-outs for fire protection system





# RANK XEROX



## Rank Xerox Acoustic Test Facility

- ISO 3745 compliant
- 100Hz cut-off frequency hemi-anechoic chamber
- Metadyne® LF anechoic wedges
- Internal test space of 200m<sup>3</sup> (between wedge tips)
- Used for testing office equipment
- Internal noise level of NR10
- Turnkey project







## York International Acoustic Test Centre

- 50Hz hemi-anechoic chamber
  - ISO 3745 compliant
  - 50Hz at 10m
- Acoustic ambients
  - Ventilation running at full capacity: 40dB(A)
  - Background ambient:  $\leftarrow$ 18dB(A)
- Air handling units (AHU'S)
  - Air volume: 100m<sup>3</sup>/s
  - Air side cooling capacity: Greater than 1.1MW
  - Supply air temperature range: -20°C — +50°C
  - Humidity capacity: 240kg/h (via steam injection)
  - Background noise levels NC20









## Industrial & OEM Acoustic Test Facility International Customer List

Customer	Description	Location
AMD	M H	USA
AP Products	M M M M M	USA
Apple Computers	Mi H M M	USA
Arcelic	M H M M	Turkey
Artc		Taiwan
AT & T	Mi H	USA
Autophon (UK) Ltd.	Mi H	UK
AWA/Aisin		USA
Bafam (Berlin Germany)		Germany
Becton Dickinson		USA
Blachford		USA
BPB America/Celotex		USA
British Telecom	Mi A	UK
Bristol Compressors		USA
Bureau of Mines		USA
Burke E. Porter		USA
C. Iber & Sons		USA
Canon Virginia		USA
Cemoter	M H	Italy
Cidco Inc.		USA
Conner Peripherals		USA
Copeland Corp.		USA
Cosi		USA
Cummins	M H x2 ★	USA
Defiance		USA
Delco Electronics		USA
Dell Computer	Mi H	USA
Deutsche Telekom Ag (Steinfurt)	Fg A	Germany
Dunn Construction		USA
Eaton Technologies Inc.		USA
Environetics		USA
Ericsson	Mi H	UK
Fachhochschule (Kiel Germany)		Germany
FG Wilson Ltd.	M H R ★	UK
Faital	M A	Italy
FBI		USA
FEV Engine Tech	M H	USA
Firma Cetecom		Germany
GE Appliances	R	USA
GHSP		USA
Goodmans Loud Speakers	Mi A	UK
Grundfos	M H	Denmark
Grundig	Mi A	Germany
Harman Consumer Group	M H	USA
Harris Corp.		USA
Hewlett Packard	Mi H	USA
HLFU (Germany)		Germany
Honeywell Inc.		USA

Customer	Description	Location
Hull City Council	Mi H	UK
IA & A Acoustics		USA
IBM Corp.	Mi H	USA
Inalfa Roof		USA
Ingersoll Rand		USA
Intel	Mi H	USA
ITT Telecom	Mi H	USA
Jabil Circuit		USA
Kelley & Associates		USA
Ketchum & Walton		USA
Kokusai Electric		USA
Lectron Products		USA
Mabe		USA
Magna Corporation		USA
Mando Machinery	M H	USA
Matsushita Electric	Mi H	USA
Maxtor Corp.	Mi A	USA
Mayo Clinic		USA
Merloni		Italy
Meyer Sound		USA
Microsoft		USA
Ministry of Defence	Mi H A	UK
Miracle Ear/Dahlberg		USA
MIT	M H	USA
MOD	M H	Israel
Motorola	Mi H	USA
MTD Products		USA
Nacco		USA
Nastech		USA
NEC America	Mi A	USA
Neuroscience	Mi A	USA
Newman Technology		USA
Nidec Corp.		USA
NIST		USA
Nokia UK	Mi A	UK
Nokia Bochum	Mi A	Germany
Nokia Copenhagen	Mi A	Denmark
Northern Telecom	Mi A	USA
Northrop Electro		USA
Nytt Rikshospital	Mi A	Norway
Oeler Industries/Polymics		USA
Ohio State University	Mi A M M	USA
OKI Telecom	Mi H	USA
Owens Corning	Mi H	USA
Oxford Speaker Company		USA
Panasonic	Mi A	UK
Penn Ventilators		USA
Phonak GmbH	Mi A	Germany

Customer	Description	Location
Pioneer Speakers Inc.	Mi A M M	USA
Pitney Bowes	Mi H M M	USA
Prince Corporation		USA
Q-Tran		USA
Ransco	Mi H	USA
Resound Corp.	M H	USA
Robert Bosch	M H M M	USA
Rockwell International		USA
Rolm Systems		USA
Rudolph Libbe		USA
Samsung	Mi H	UK
Sanitherm Engineering		USA
SCJ Associates		USA
SDRC	M H	USA
Seagate Technologies	Mi H	USA
Shure Brothers		USA
SIAC	M H	Singapore
Simpson		USA
Singer Controls		USA
Smith Corona Corp.		USA
Standard Telecommunication Lab.	Mi A	UK
STC Telecommunications Ltd.	Mi A	UK
Sunbeam Oster		USA
Sverdrup Technology Inc.		USA
Systems Mat'l Handling		USA
Tokai Rika		USA
Tokia Rubber		USA
US Army		USA
US Dept. of Labor		USA
USA Medical Research	Mi A	USA
VDE	H	
Veridian Veda Operations		USA
Vertu	Mi A	UK
W.E. O'Neil		USA
Western Digital		USA
Walbridge Aldiner		USA
Walker		USA
Whirlpool Singapore	M H	USA
Xerox Corporation	M H ☆	USA
Yazaki Eds Eng		USA
Yazaki N.A.		USA
York International	H ☆	UK
Yosemite Trading		USA

## Key

-  Metadyne® Wedges
-  Microdyne® Foam Wedges
-  Microdyne® Fiberglass Wedges
-  Planarchoic™ (flat) Panels
-  Full Anechoic Chamber
-  Hemi-anechoic Chamber
-  Listening Room
-  Reverberation Chamber
-  Turnkey Project



The image shows the interior of an acoustic test facility. The walls and ceiling are covered with numerous grey, pyramid-shaped acoustic absorbers designed to eliminate reflections. Two bright spotlights are visible, casting light on the absorbers. In the foreground, a metal grating floor is visible, with several cables (green, purple, black) running across it. On the right side, a black speaker is mounted on a stand. A large, semi-transparent blue graphic consisting of concentric, overlapping circles is overlaid on the center of the image.

# High Performance Acoustic Test Facilities

For education and  
acoustic research  
organisations









Hemi-anechoic chamber for the University of Salford

## Acoustic Testing for Education and Cutting Edge Research & Development

In addition to being the world's largest supplier of noise control solutions to industry, IAC is also unique in its ability to provide some of the best acoustic test facilities to colleges, universities and research groups around the globe. Specialist education establishments where cutting edge research is carried out, demand the highest acoustic specifications for their facilities. IAC has been privileged to have worked with some of the best organisations worldwide.

### Typical Construction

Anechoic facilities used by research institutions are typically constructed from IAC modular acoustic panels to the configuration of either Schedule 40 (single wall) or 60 (double wall) Microdyne® chambers.



Fully anechoic chamber for University College London (UCL)



“ IAC is able to supply pure-tone anechoic facilities for research institutions. ”

### IAC Clients

IAC has worked with the following organisations for high-specification acoustic test facilities:

- Institute of Sound & Vibration (ISVR) at Southampton University
- National Physical Laboratory (NPL)
- Salford University
- McQuarie University
- CEM
- Imperial College London
- Oxford University
- University College London (UCL)
- SATRA Technology

### Schedule 60 Microdyne® Chambers

The IAC Microdyne® Schedule 60 anechoic room is designed for the research physicist or engineer who must make precise sound measurements in a free-field acoustic environment. Schedule 60 rooms provide high sound transmission loss (TL) characteristics and have a completely anechoic wedge lined interior to meet these requirements.

For maximum sound isolation, IAC Schedule 60 rooms are designed as a room within a room featuring certified IAC Noise-lock® and Moduline™ components. The inner room is set on a vibration isolation system created for the specific weight and frequency cut-off of the room.

### Schedule 40 Microdyne® Chambers

Schedule 40 chambers are designed for applications and locations where the noise reduction characteristics for a single wall and ceiling construction provide adequate noise isolation.

The single wall construction results in smaller overall outside dimensions and is particularly suited to placement in less noisy areas. In every other respect, the Schedule 40 is similar to the Schedule 60 series with the same standard features and options available.

making the world a quieter place



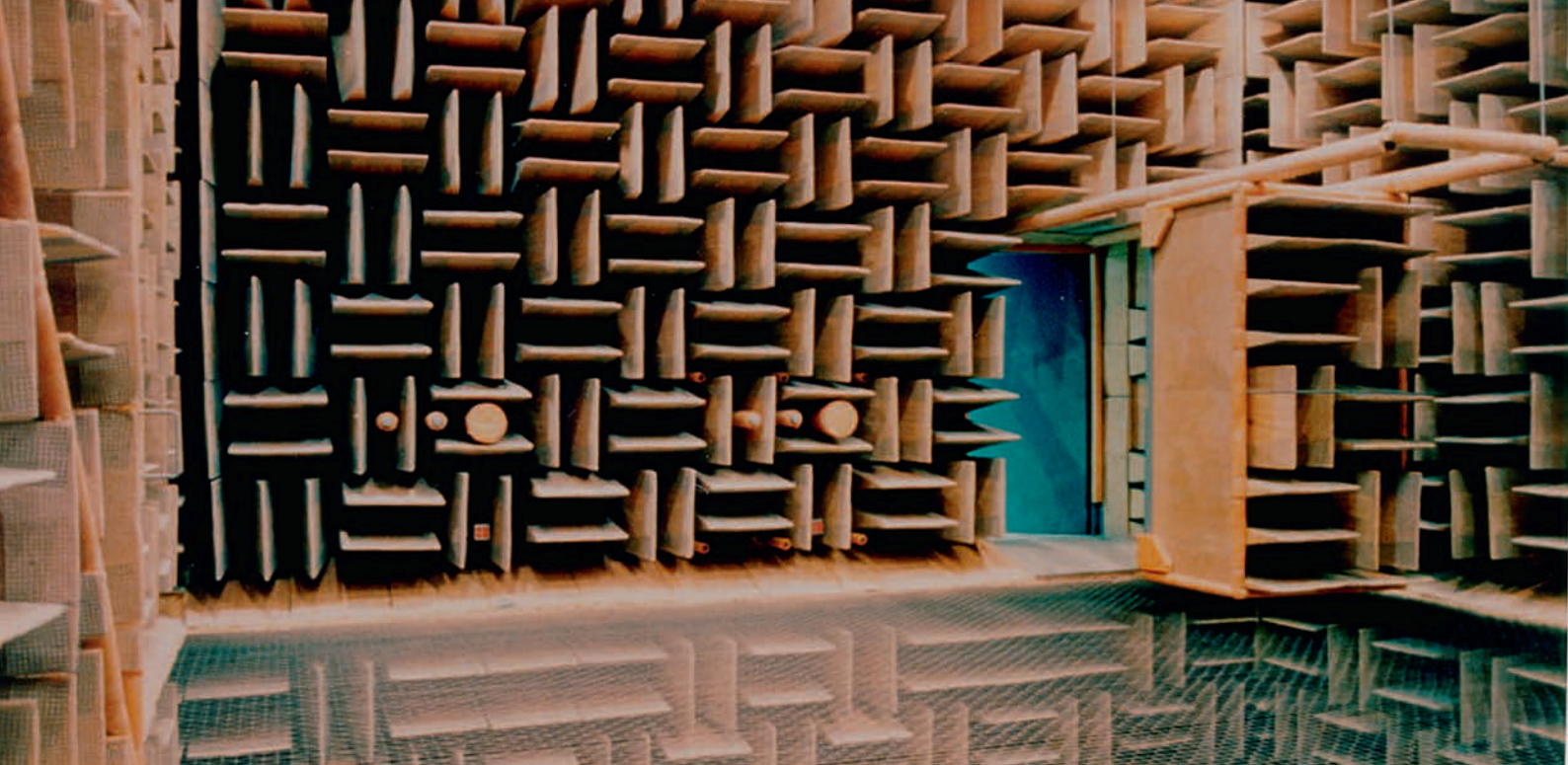

## Standard Features

Microdyne<sup>®</sup> anechoic rooms come with the following standard features:

- Anechoic wedges (foam, fibreglass or IAC Metadyne<sup>®</sup>) with the required low-frequency cut-offs
- Double or single wall and ceiling construction
- IAC standard ventilation system coupled to the building supply
- Lighting (interior) minimally acoustically reflective
- Tubular cable ports
- Interior non-reflective cable floor system above the floor wedges with a nylon catch net below
- IAC Acousti-flote<sup>™</sup> floor system with vibration isolators
- One IAC Noise-lock<sup>®</sup> wedge acoustic door

## Options

- Floor grating for chambers which will house heavy items
- Additional or larger Noise-lock<sup>®</sup> acoustic doors
- Access panels for equipment and test openings
- Double Acousti-flote<sup>™</sup> floor for Schedule 60 anechoic rooms
- Air mounts, springs or other types of vibration isolators
- Independent ventilation system
- RF shielding

## Floors

Fully anechoic chambers pose a challenge when people need to enter the facility in order to place items under test. IAC has developed a range of floor solutions to minimise reflective sound. Typical installations utilise a grid-based system to maximise the absorption of the floor wedges. IAC also uses a range of cable floors to support people and heavy test objects. For some very high specification facilities, IAC has developed a range of retractable floors which completely remove any reflective surfaces when in use to achieve the most accurate measurements.

### Cable Floors

IAC fully anechoic chambers are typically provided with a tensioned cable floor, situated approximately 100mm above the tips of the floor wedges. Beneath this cable floor is a nylon catch net to prevent debris and small objects falling out of reach.

The cable floor consists of stainless steel cable interwoven in a criss-cross matrix of 50mm separation. Each cable is tensioned from an acoustically lagged steel ring beam by turnbuckles at one end and a coil spring at the other. This ensures that the floor is strong with even deformation and spring characteristics.



Example of Microdyne® fully anechoic chamber with grated floor for ISVR in Southampton



Example of Microdyne® fully anechoic chamber with cable floor plus additional platform for Deutsche Telekom

## Typical Uses of Precision Chambers

Typical uses of IAC's range of high precision anechoic and hemi-anechoic chambers include:

### Microphone Calibration

- Primary calibration, free-field reciprocity method
- Secondary calibration by the substitution method
- Frequency response and directivity

### Sound Level Meter Calibration

- Pattern evaluation
- Frequency response
- Directivity

### Psycho-acoustic Testing

- Sound perception testing is typically used for research and development of products
- An example of research carried out was by Stable Micro Systems Ltd at NPL in the UK where tests were carried out on the "crispiness" of biscuits and their effects of peoples' perceptions of taste

### Sensory Deprivation Testing

- Used for military and educational research

### Speaker Research & Development

- Sound power output measurements
- Physical speaker design
- Distortion and frequency response

### Acoustic Science

- PhD projects
- Ultrasound scanning research
- Virtual acoustics – generating auralisations of concert halls, city streets and other spaces

### CE Marking/Certification

- All machines are required to have a sound power output test carried out prior to being released for sale
- Testing of toys to ensure suitability for hearing in children
- Items such as hearing protectors are required to be tested in an anechoic chamber to measure their effectiveness

### Hearing Research

- Free-field audiometry
- Cochlear implant testing



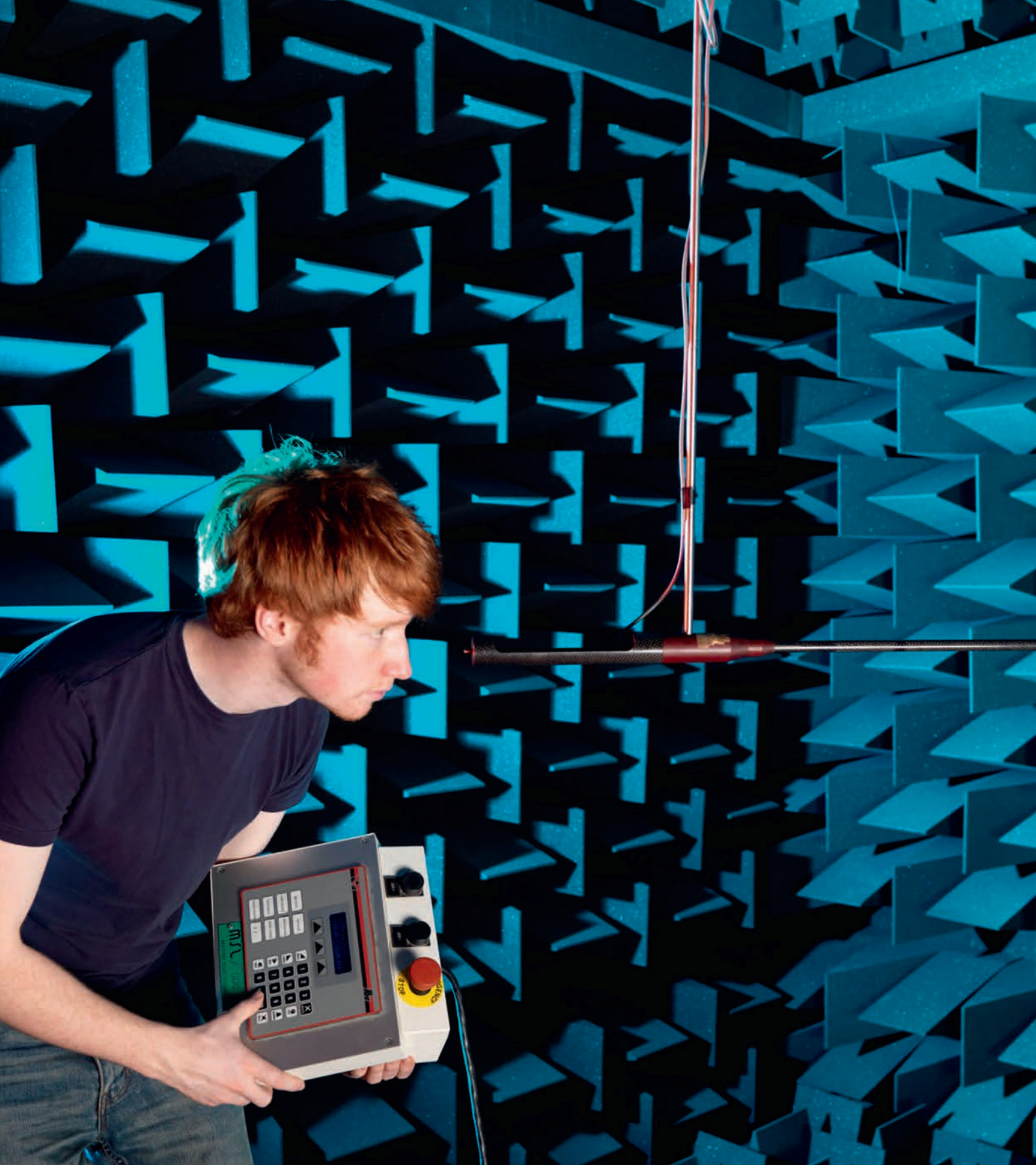

High-precision fully anechoic chamber for pure-tone measurements for NPL, UK

---

## IAC Project – National Physical Laboratory (NPL)

- Fully anechoic facility
  - 125Hz cut-off frequency
  - ISO 3745 compliant for pure-tone anechoic chambers
  - Unique twisting basket door arrangement
  - Fire retardant foam wedges
  - Integrated microphone positioning system
- 

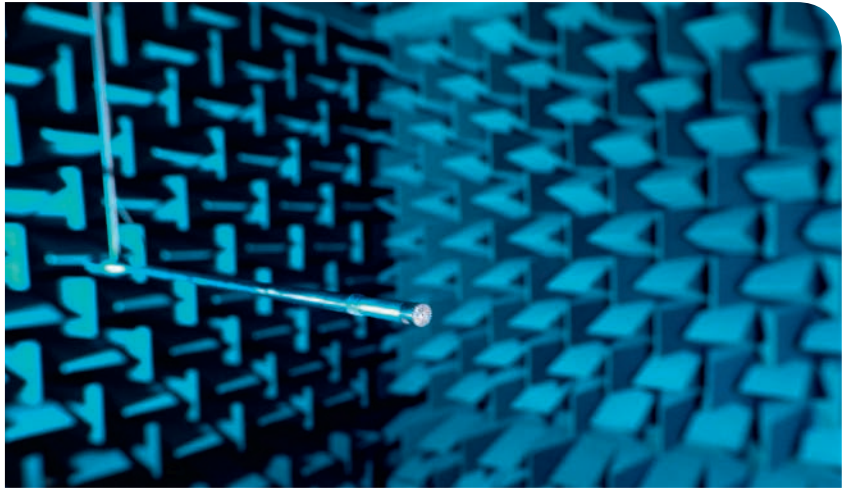

The UK's national measurement institute, the National Physical Laboratory (NPL), is a world-leading centre of excellence in developing and applying the most accurate measurement standards, science and technology. Its acoustics team provides the primary standards for sound pressure in air in the UK. In order to support their research and calibration requirements, IAC refurbished and commissioned the acoustic anechoic chamber.

This new anechoic chamber provides exceptional free sound field conditions at frequencies from 125Hz to 20kHz and is primarily used for free-field calibration of microphones. The facility exceeds the requirements defined in ISO 3745 for pure-tone anechoic chambers ( $\leq 0.5$ dB deviation from free-field behaviour with root-mean-square deviations as low as 0.04dB). The chamber is formed with a concrete shell, lined on all surfaces with an absorbent treatment of over 1600 fire-retardant foam wedges. The result is a near perfect free sound field with ambient noise levels in the chamber of lower than NR1 to ensure low measurement uncertainties.

Devices under test may be mounted on a computerised traversing mechanism which runs along the centre line of the chamber. This provides source-receiver separations along the nominal axis of the chamber's sound source and ensures accurate and repeatable positioning of the test device.

A suspended retractable floor allows access to the room. During measurements, this is withdrawn to expose the floor wedges, thereby creating the perfect free-field. The floor is removed by means of a rolling mechanism, storing the grid beneath the floor wedges.

---

“Since its commissioning, the NPL free-field chamber has been used extensively, delivering world-class measurement results in a number of research projects, for example in characterising novel transducers, as well as reliable calibration data for our clients.

In a recent international project to evaluate methods for determining the free-field performance of sound level meters, results determined in the NPL chamber were found to be comparable with data from other laboratories where post-processing had been applied and were significantly better than others where such techniques were not used.”

**Richard Barham**  
Principal Research Scientist NPL

---



---

## IAC Project – The University of Salford

- Fully anechoic chamber with 100Hz cut-off
  - 2 hemi-anechoic chambers each with 250Hz cut-off
  - 4 acoustic studios complete with adjoining control rooms
  - Anechoic/hemi-anechoic chambers are all ISO 3745 compliant
- 

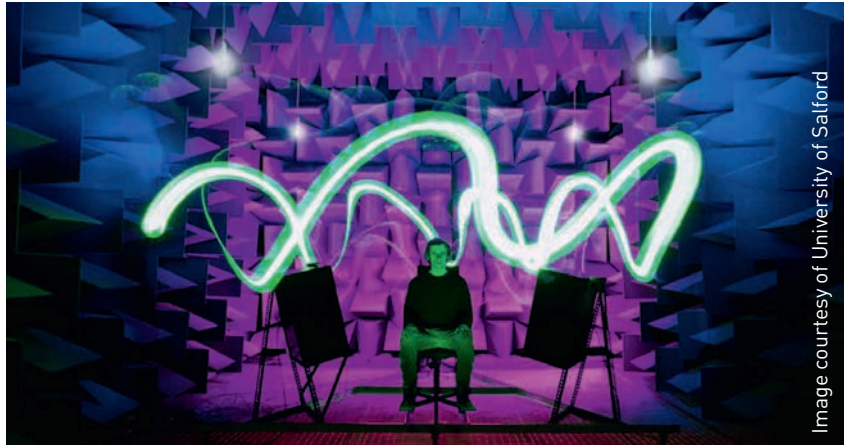

The University of Salford approached IAC to provide a number of different acoustic facilities for their Acoustics, Audio and Video Engineering Department. Included in the test environments provided were a single fully anechoic chamber with a 100Hz cut-off frequency, a pair of hemi-anechoic chambers, each with a cut-off frequency of 250Hz and a block of 4 acoustic studios, all with adjoining control rooms.

Used by students, researchers and commercial clients, the acoustic test facilities completed by IAC were part of a £2.5m investment programme by the University of Salford.

The anechoic chamber was constructed as a room within a room to prevent sound from getting into the chamber and the inner walls and floor were mounted on anti-vibration pads and springs to prevent structure-borne

noise. The chamber itself incorporates a unique set of double acoustic sliding doors and uses a tensioned cable floor to minimise reflective sound.

This chamber is predominantly used for testing the sound attenuation of hearing protectors, but is also used by PhD students who require very precise sounds to be reproduced.

The pair of hemi-anechoic chambers are of a single wall construction and identical in terms of size and performance. One is used for commercial purposes and the other is solely utilised for teaching. The teaching laboratory is typically used for noise measurement and measuring the response of loudspeakers.

In addition to the anechoic facilities, IAC also constructed a suite of 4 acoustic studios, three digital and one analogue. The four control rooms were built around four live rooms that are interlinked to allow recording from multiple live rooms for maximum isolation between instruments. One live room was dedicated for drums and as such had a higher level of acoustic isolation.

The studios were built to high acoustic specifications, to provide an accurate monitoring environment. Each room has been placed on acoustic dampers to isolate them from outside noise and each other. Between the control rooms and performance areas, quadruple glazed windows were installed to allow good visual contact between musicians and the studio engineer.







University of  
**Salford**  
MANCHESTER

Fully anechoic chamber, part of a range of facilities provided for the University of Salford, Manchester





Hemi-anechoic chamber for SATRA Technology,  
Nottinghamshire, UK

---

## IAC Project – SATRA Technology

- Hemi-anechoic chamber
  - 125Hz cut-off frequency
  - ISO 3745 compliant
  - Fire retardant foam wedges
  - Integrated speaker mounts
  - Double-wall construction
  - Performs as specified, despite a background noise of around 70dB(A) in the surrounding area
- 

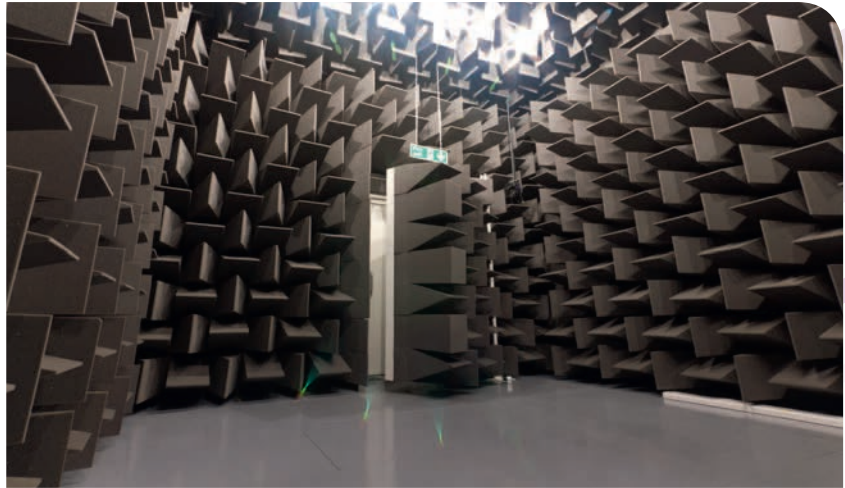

IAC was approached by SATRA Technology, one of the world's leading research and technology centres of its kind to build and commission a hemi-anechoic chamber with a very high acoustic specification.

Formed in 1919 SATRA helps manufacturers and suppliers to evolve by providing technical knowledge, research and testing. Currently commissioned for testing various PPE items such as high visibility clothing, footwear and protective eyewear, SATRA wanted to be able to offer testing of hearing protection to their portfolio. In order to certify, test and develop products such as ear defenders for various manufacturers, an anechoic chamber was required.



Positioned within an existing building with other kinds of research being carried out on a day-to-day basis, the proposed chamber needed to meet a demanding acoustic

specification despite a high background noise level of around 70dB(A) within the host structure. With this in mind, the new facility was configured as a room within a room and constructed using IAC's Moduline™ acoustic panel system. The inner chamber is structurally isolated from the outer skin using a series of anti-vibration mounts and an air gap between the two walls helps to further increase the acoustic performance.

The internal walls and ceiling of the chamber were covered with foam anechoic wedges of an appropriate size and length to achieve the 100Hz cut-off frequency target set by SATRA in the specification. Access to the chamber is via a set of IAC Noise-lock® linked acoustic doors between the two skins and a wedge basket door at the room entrance to ensure maximum internal sound absorption.

Due to the nature of the core function of the facility which is for hearing protection products, IAC worked closely with SATRA at the design phase to incorporate an array of mounts for holding speakers. The speakers, act as the noise source for which products on test will be graded.

Commenting on behalf of SATRA, Andy Todd, Acoustic Engineer said: "The new hemi-anechoic chamber will help to widen the range of services SATRA is able to provide, not only for hearing protectors, but hopefully other products in the future. Overall the project ran very smoothly and the new chamber performs very well."



---

## IAC Project – Lorient

- Transmission suite
  - BS EN ISO 10140 compliant
  - Moveable walls to accommodate different size doors and offer flexibility
  - High performance acoustic doors used
  - Background noise level of less than 20dBA
- 



Lorient Polyproducts Ltd, based in Devon, design and manufacture market-leading, high-performance door sealing systems, helping to contain sound within a room and also shield unwanted noise from entering. With 35 years experience, Lorient is respected throughout the industry for their technical knowledge.

IAC was approached by Lorient, to build and commission a facility to enable them to develop and test their products in compliance with parts of BS EN ISO 10140. Compared to standard IAC Acoustic products, the project at Lorient was completely bespoke and entailed an entirely new installation. The Global Acoustic Test Facilities team at IAC designed, supplied and installed a transmission suite, for measuring airborne sound and was suitable for testing to the acoustic parts of BS EN ISO 10140:2010. The suite needed to be designed 'dismountable' so that it could be disassembled, relocated and assembled in another location at a future date. The suite also needed to include a variable sized opening to readily install double doors, single doors or windows, with a blanking panel system that reliably ensured a repeatable baseline transmission loss through the wall.

IAC designed Lorient a unique plug panel system to allow the versatility to switch between door and window configurations. IAC Acoustics STC-53 and STC-64 acoustic doors provided the noise isolation from the busy nearby factory floor to inside the testing rooms, resulting in a working background noise level of less than 20dBA. The reverberation times within the suite were tuned using IAC Absorbatone panels, ensuring that the reverberation times met the recommendations in the Standard.

A full commissioning service was included which included qualification of appropriate sound source and microphone positions, measurement of the Rmax condition, reverberation time measurements, checks on electrical noise floor and cross-talk and background noise. Commenting on behalf of Lorient Polyproducts Ltd, Dunstan Ferris, Technical Consultant said, "We are very happy with the level of professionalism delivered by IAC Acoustics and the finished product is not only highly impressive, it also meets the specifications required".

making the world a quieter place

A decorative graphic consisting of several overlapping, concentric, wavy lines in shades of blue, located at the bottom left of the page.



**LORIENT**

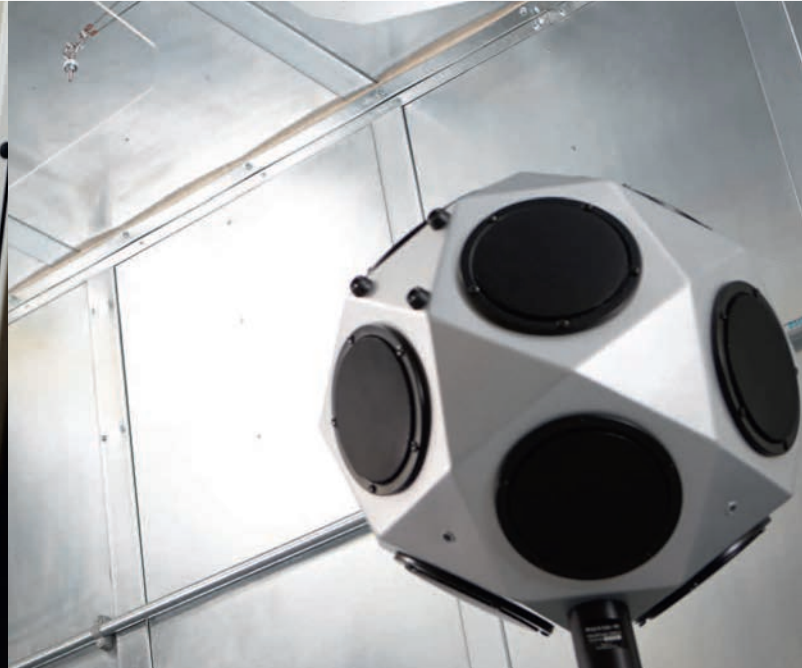



---

## IAC Project – Solent Acoustics, Southampton Solent University

- 100Hz cut-off rating
  - Very high performance for a single wall construction
  - Chamber used for practical laboratory testing
  - Microdyne foam anechoic wedges used
- 

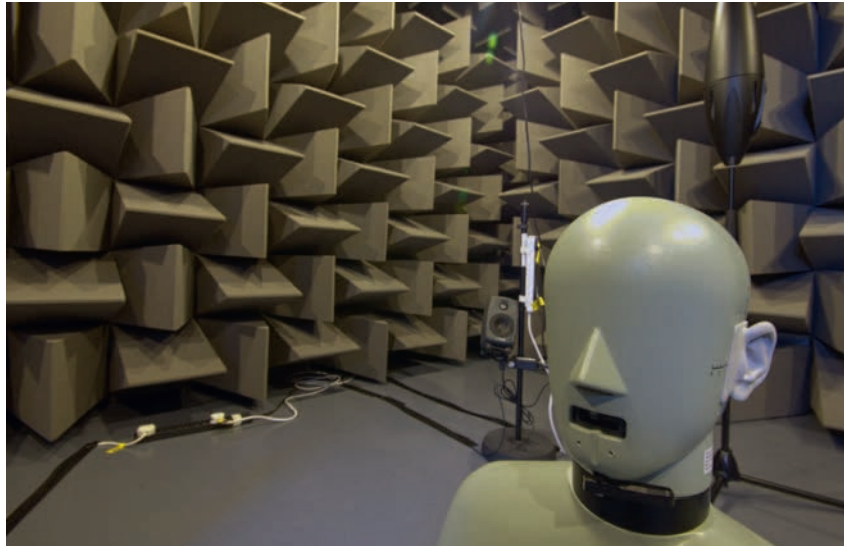

IAC was approached by Solent Acoustics, part of Southampton Solent University, to build and commission a single-walled hemi-anechoic chamber, to enable teaching and research for its students. The University also has a long-term view of renting the space to local companies for testing and certifying products and components.

Solent Acoustics provides a range of consultancy and training services for the industrial and educational sectors, specialising in training, education and CPD relating to noise and acoustics. In addition, they provide a range of services for sound isolation testing (Part E), through to Environmental and Occupational Noise measurements to conduct research for product development.

Solent Acoustics wanted a modular system that could be used for teaching, along with other capital investments in equipment, enabling them to run various Institute of Acoustics (IAO) courses such as the Diploma in Acoustics. The chamber would also be used for PHD students to conduct research specialising in acoustics.

The internal walls and ceiling of the chamber were covered with foam anechoic wedges of an appropriate

size and length to achieve the 170Hz cut off frequency target set by Solent Acoustics. After completing the project, the chamber was tested and actually achieved 100Hz. Solent Acoustics were understandably very pleased with the outcome and performance of the chamber, with low internal noise levels of 16dB (A) and NR18 achieved through a single wall chamber.

Commenting on behalf of Solent Acoustics, Christopher Barlow, Associate Professor of Acoustics said,

---

“I am more than happy with the level of performance of the hemi-anechoic chamber installed by IAC Acoustics. Having specified a cut off frequency of 170Hz we were very impressed when the chamber achieved 100Hz, enabling us to take a wider range of measurements at lower frequency. Overall the project ran smoothly and it was a pleasure to work with IAC.”

---



iac acoustics

## Hemi-anechoic Chamber

www.iac-acoustics.com

IAC Acoustics Moduline™ acoustic panels

$D_w = 56$   
 $R_w = 50$

IAC Acoustics VE25/130 foam wedges

24 dBA NR 18

Anechoic Region  
100 Hz - 20 kHz  
(ISO 26101 and ISO 3745)

Fan Speed	Average Sound Pressure Level [dBA]	Noise Rating [NR]
Off	16.2	18
1	16.9	18
2	17.8	18
3	19.2	18
4	20.4	18
5	23.2	18

Complies with ISO 3745 absolute background noise

skin hemi-anechoic chamber lined with IAC Acoustics VE25/130 foam wedges

and noise level of less than 24 dBA with noise rating

level difference  $D_w = 56$  with weight



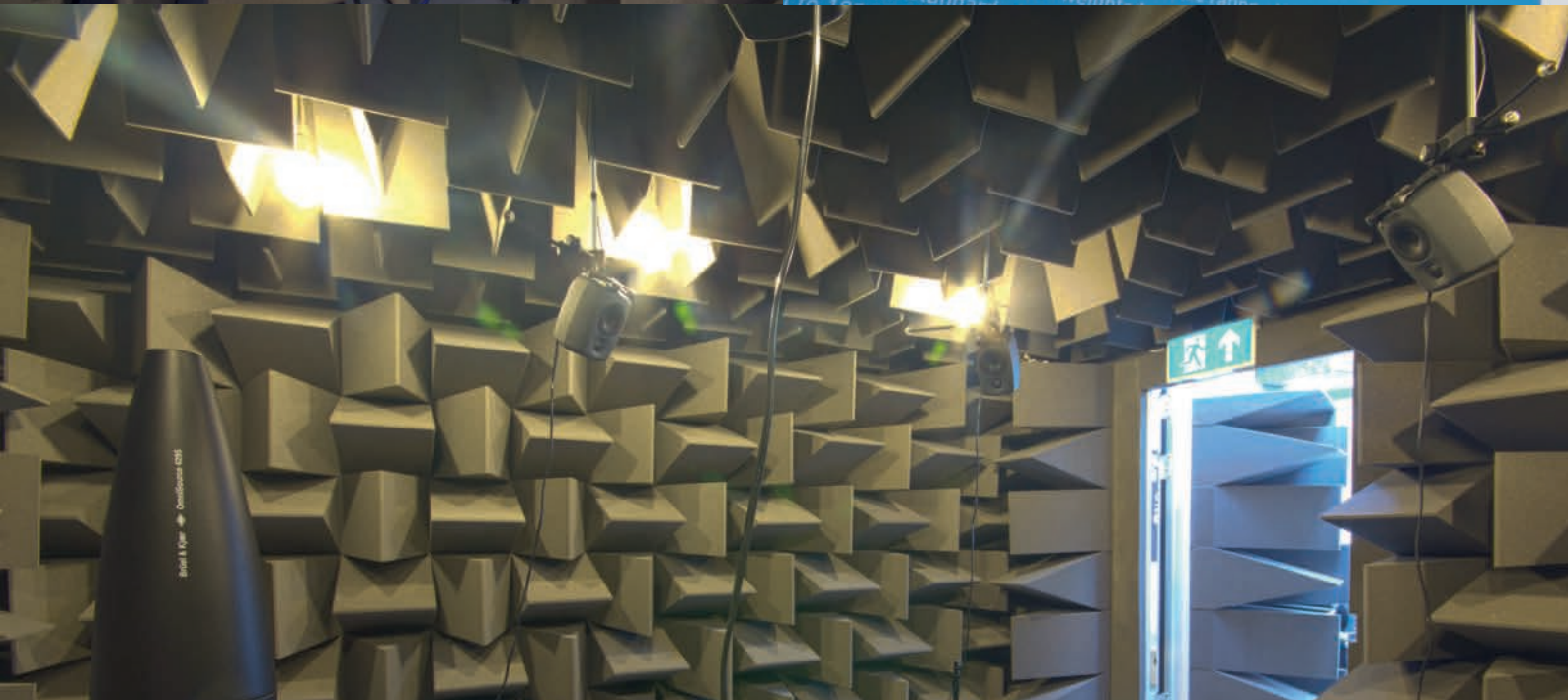

























































qualification standard











Southampton  
**SOLENT**  
University



## Academic & Research Acoustic Test Facility International Customer List

Customer	Description	Location
Aberystwyth University		UK
BSI	 	UK
CEM	  	Spain
Department of Science		USA
Edinburgh University	    	UK
Goodmans Hi-Fi	  	UK
Harman Becker	  	UK
HSL Buxton	  	UK
Imperial College London	 	UK
Institute of Sound & Vibration Research (ISVR)	 	UK
Lorent		UK
McQuarie University	 	Australia
MIT	 	USA
MOD Aquilla	 	UK
National Physical Laboratory (NPL)	  	UK
Neuroscience Department		USA
Ohio State University	 	USA
Oxford University	 	UK
Portsmouth University	 	UK
Qinetic	  	UK
Salford University	    	UK
SATRA	 	UK
Southbank University	 	UK
Southampton Solent University		UK
Strathclyde University		UK
University College London	 	UK
University College Northampton		UK
University of Southampton	 	UK
US Army		USA
US Dept. of Labor		USA
USA Medical Research		USA
Warwick University		UK

### Key

-  Metadyne® Wedges
-  Microdyne® Foam Wedges
-  Microdyne® Fiberglass Wedges
-  Pure-tone Certified
-  Full Anechoic Chamber
-  Hemi-anechoic Chamber
-  Listening Room
-  Reverberation Chamber
-  Turnkey Project



TANNOY



## IAC GmbH

T: +49 2163 9991-0

E: [deutschland@iac-gmbh.de](mailto:deutschland@iac-gmbh.de)

[www.iac-gmbh.de](http://www.iac-gmbh.de)

For a list of IAC locations worldwide please refer to our website.

TW\_UKCOR\_001 05\_13

